



## PRODUCT SPECIFICATION

Product Name: LED Floodlight

Product model: NSFL-200W-65K NSFL-200W-30K

DESCRIPTION : LED Floodlight



### ● Features

1. Using die-casting aluminum with good appearance for high class looking.
2. Built-in constant current driver for high efficiency and stability.
3. Imported SMD chip light source is adopted, with high light efficiency and long life.
4. Quick response time, the LED response time is nanosecond.
5. Environmental protection, no heavy metals and harmful gas.
6. Energy-saving, can save energy more 80% than traditional lights.
7. No flicker, start quickly, soft light, protect your eyes.
8. Easy to install and use.

### ● Technical Parameter

Model	NSFL-200W
LED model	2835
LED Qty	240PCS
Power	200W
Voltage	AC110-240V

Working Frequency	50/60HZ
Power Efficiency	≥ 85%
Luminous Flux	18000LM
Efficiency	90LM/W ± 10%
Power Factor	≥ 0.9
Colour Temperature	WH: 6500K(6020-7040) WW: 3000K(2875-3215)
CRI	Ra ≥ 80
Beam Angle	110°
Working Temperature	-20 to + 50 °C
Service life	30,000hr life 5yr warranty

● Relative Spectral Energy Distribution

NSFL-200W-65K

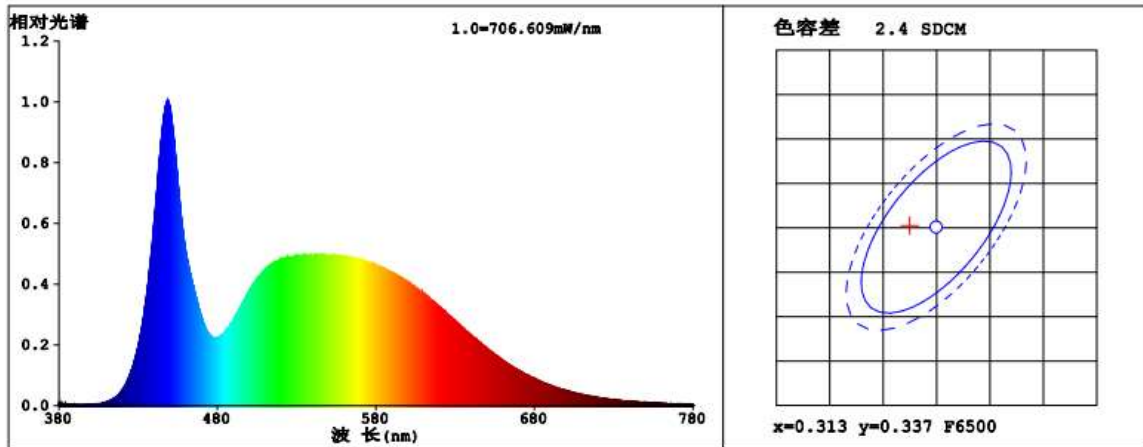

# NSFL-200W-30K

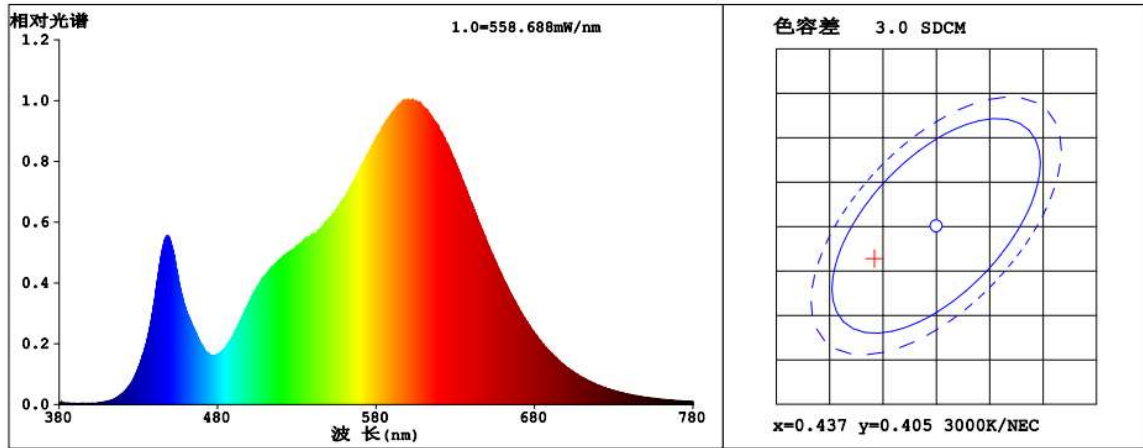

## ● Optical characteristic curve

### NSFL-200W

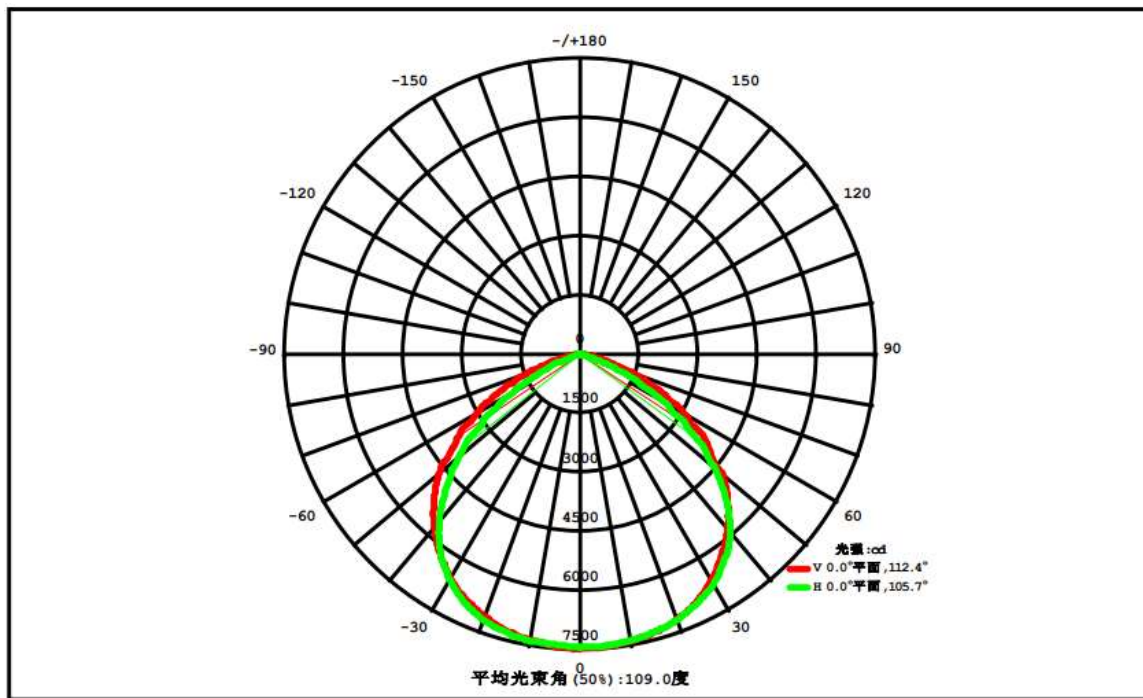

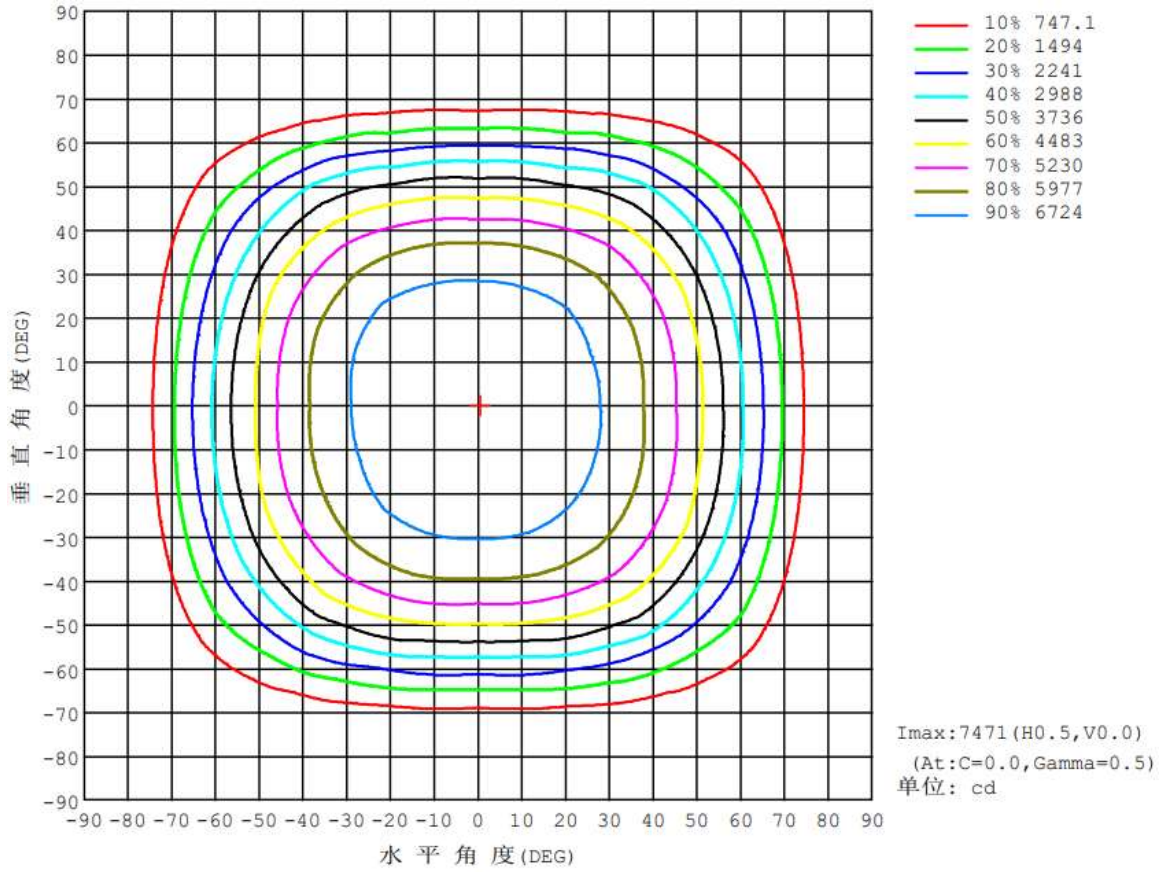

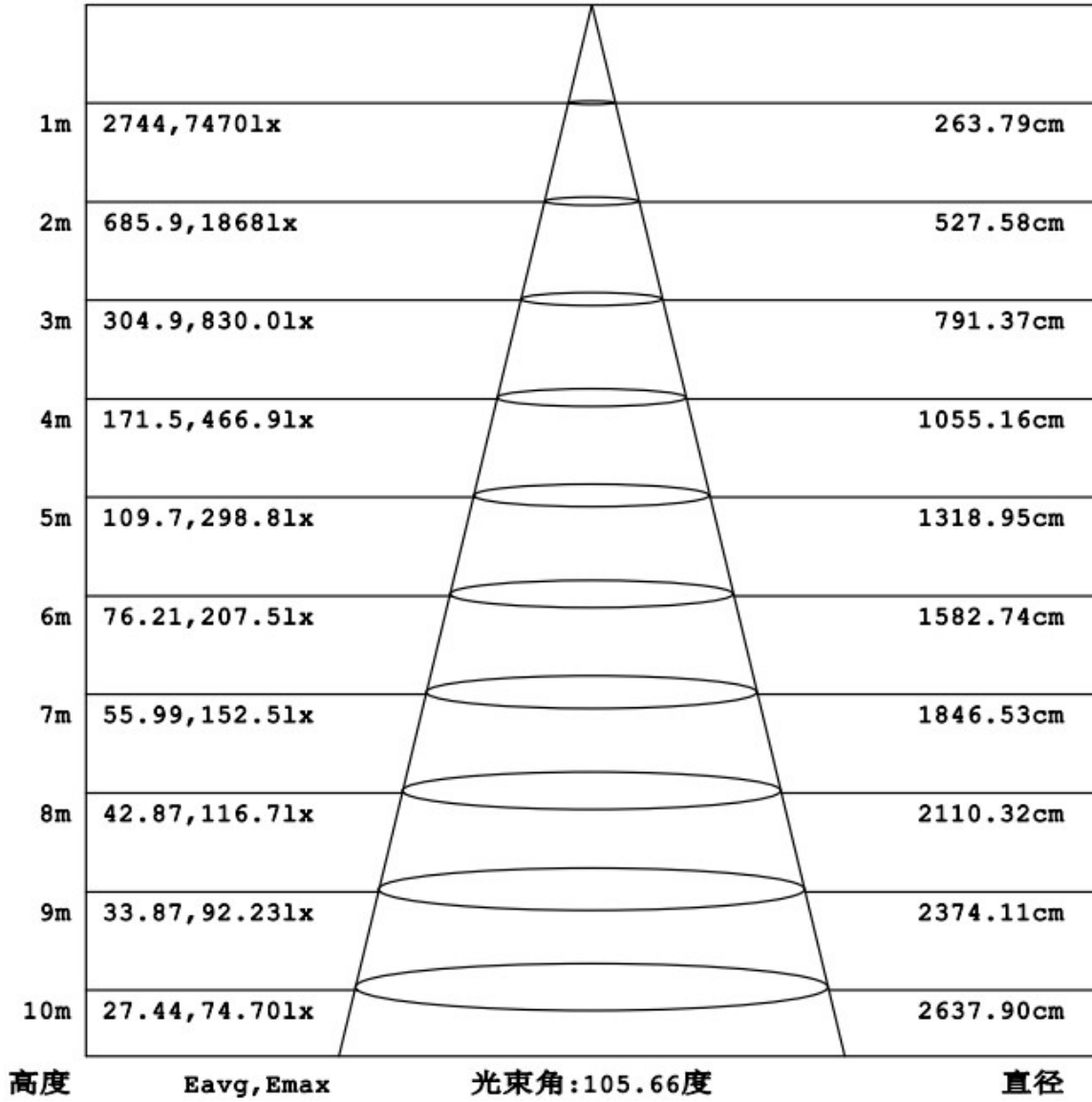

● Dimensions

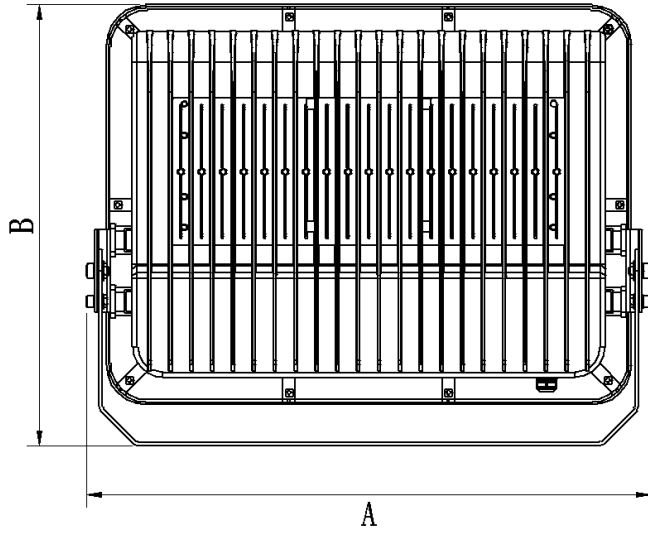

Model	Diameter (mm)	A(mm)	B(mm)
NSFL-200W-65K	/	423± 1	325± 1
NSFL-200W-30K	/	423± 1	325± 1

● Instruction of wiring

1. Diagram of power supply wiring :

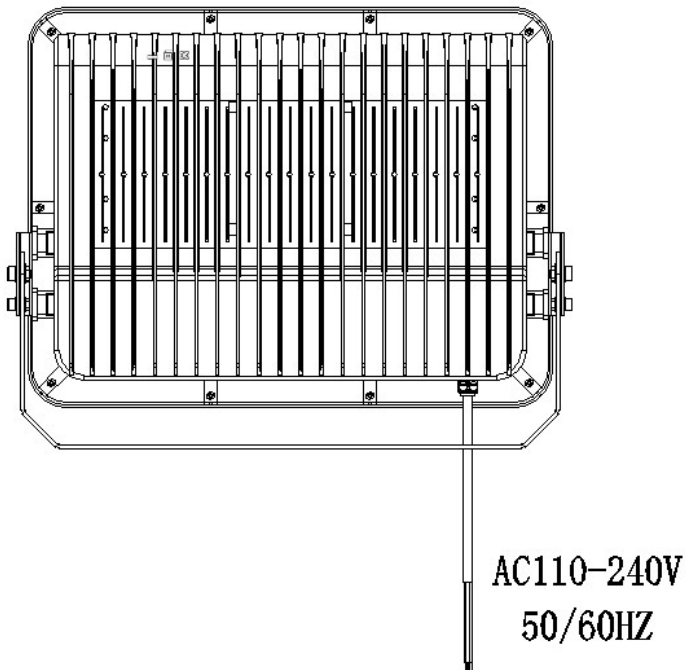

## ● Installation Instructions

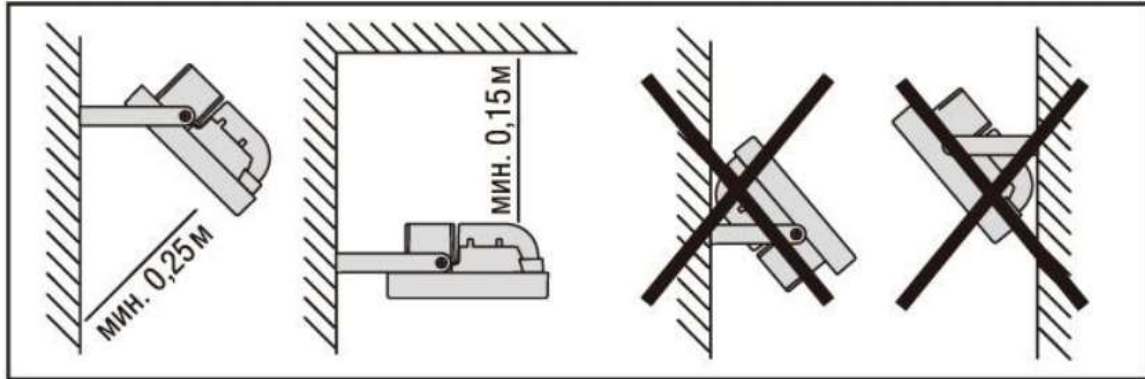

1. Fix the fixture to the wall with screws;
2. Connect power and lamp;
3. Fix the lamp with fixture on ceiling by screw;
4. Finish installation and put the power on.

## ● Product weight

N.W : 4.2Kg/PCS

G.W : 5.0Kg/PCS

## ● Product Package

Packed in color box,4PCS/ case



## ● Product Photo











● Packing size & Pictures:

Model	L (mm)	W (mm)	H (mm)
NSFL-200W-65K	495	400	120
NSFL-200W-30K	495	400	120







01.02.13.071.8103彩盒-495×400×120mm-250g灰底白+双120g芯+双E坑-四色-覆光膜-NSFL-200W-65K-A49-V1

01.02.13.071.8102彩盒-495×400×120mm-250g灰底白+双120g芯+双E坑-四色-覆光膜-NSFL-200W-30K-A49-V1

01.02.13.041.5413外箱-515×500×420mm/250g灰底白+535A(双120g芯) EB坑-四色-覆光膜-NSFL-200W-65K-A49-V1

  <p>                 92 000 30 46                  www.nasco-global.com                  200W                  LED FLOOD LIGHT             </p>	<p> <b>5 YEARS</b>                  Model No.: NSFL-200W                  POWER: 200W                  CCT: 5500K                  QTY: 4 PCS                  N.W: 16.9 KGS                  G.W: 20.9 KGS                  MEAS: 51.5x50x42 cm                  MADE IN CHINA             </p> 	  <p>                 92 000 30 46                  www.nasco-global.com                  200W                  LED FLOOD LIGHT             </p>	<p> <b>5 YEARS</b>                  Model No.: NSFL-200W                  POWER: 200W                  CCT: 5500K                  QTY: 4 PCS                  N.W: 16.9 KGS                  G.W: 20.9 KGS                  MEAS: 51.5x50x42 cm                  MADE IN CHINA             </p> 
--	--	--	--



### ●Attentions

1. Make sure the power is off before maintenance.
2. Clean the glass of diffuser of lamp regularly to maintain good light transmittance.
3. Clean the dust of the shell to maintain good heat dissipation performance.
4. Be careful not to use water or corrosive solution for cleaning, it is better to use a dry cloth.

### ●Warranty and After-sales Service

The period of guarantee is 5 years. Quality assurance is based on the correct storage, installation, use and maintenance of products. Due to improper installation and improper use of the product, the product is damaged beyond the scope of this warranty. During the warranty period, We will choose to repair, replace (spare parts) with new products. Labor charges or material costs will be appropriately collected over the warranty period.

● Products Application Cases





The date listed in this file is for reference only, and the specific date should be subject to the specific products, if any change, sorry for no notice.