



PRODUCT SPECIFICATION

Product Name: LED Outdoor Lamp

Product model: NSOL-16W-WH、NSOL-16W-WW、NSOL-22W-WH、NSOL-22W-WW

DESCRIPTION : LED Outdoor Lamp (Damp-proof lamp)



● Features

1. With a PC, it looks good and looks high-end.
2. Built-in constant current driver for high efficiency and stability.
3. Imported SMD chip light source is adopted, with high light efficiency and long life.
4. Quick response time, the LED response time is nanosecond.
5. Environmental protection, no heavy metals and harmful gas.
6. Energy-saving, can save energy more 80% than traditional lights.
7. No flicker, start quickly, soft light, protect your eyes.
8. Easy to install and use.

● Technical Parameter

Model	16W	22W
LED model	SMD 2835	
LED Qty	36 PCS	52PCS
Power	16W	22W

Voltage	AC110-240V	
Working Frequency	50/60HZ	
Power Efficiency	≥ 85%	
Luminous Flux	1350LM	1950LM
Efficiency	85LM/W ± 10%	90LM/W ± 10%
Displacement Factor	≥ 0.7	
Colour Temperature	WH: 6500K(6020-7040)	
	WW: 3000K(2875-3215)	
CRI	Ra ≥ 80	
Bean Angle	125°	
Working Temperature	-20 to + 45 °C	
Service life	30,000hr life 5yr warranty	

● Relative Spectral Energy Distribution

NSOL-16W-WH、 NSOL-22W-WH

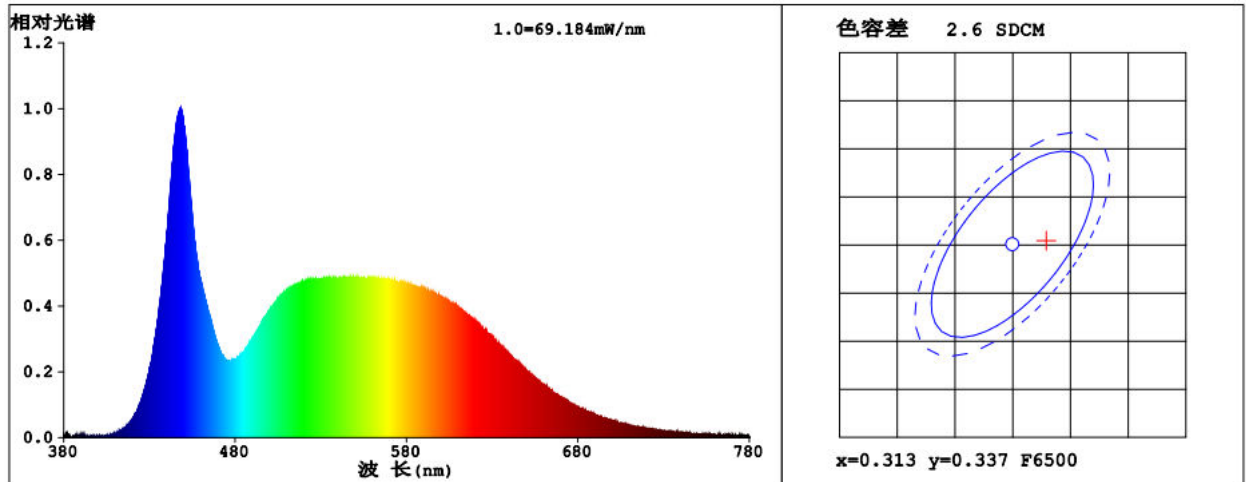

NSOL-16W-WW、NSOL-22W-WW

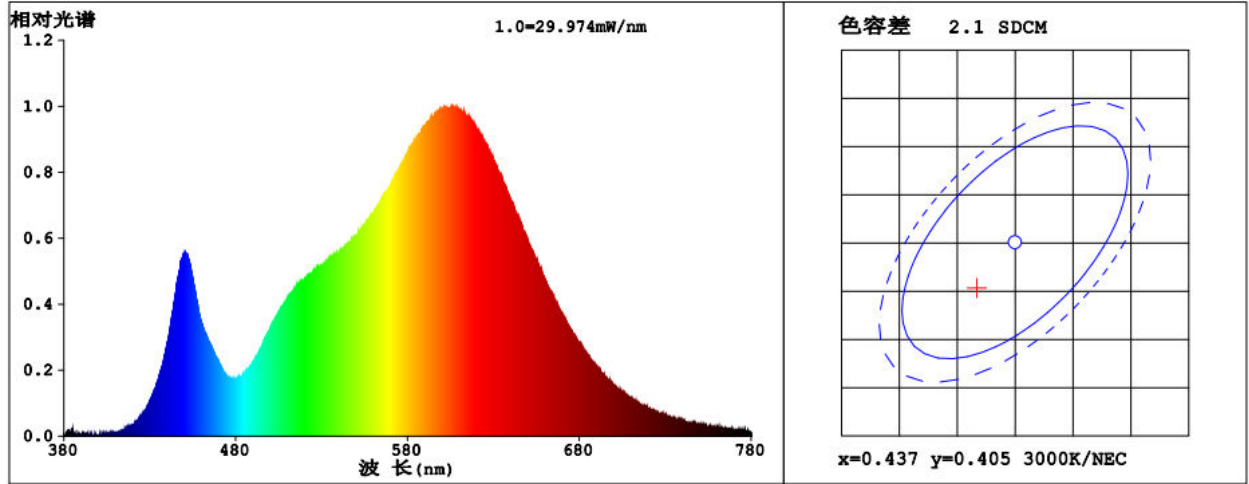

● Optical characteristic curve

NSOL-16W-WH、NSOL-16W-WW

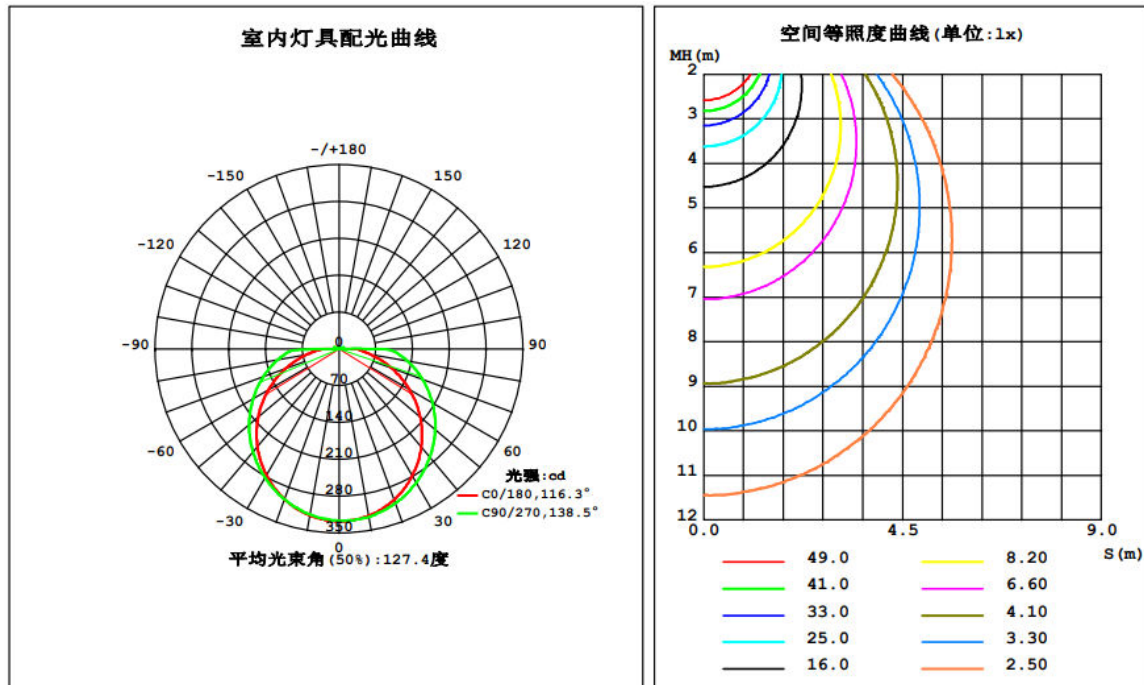

NSOL-22W-WH、NSOL-22W-WW

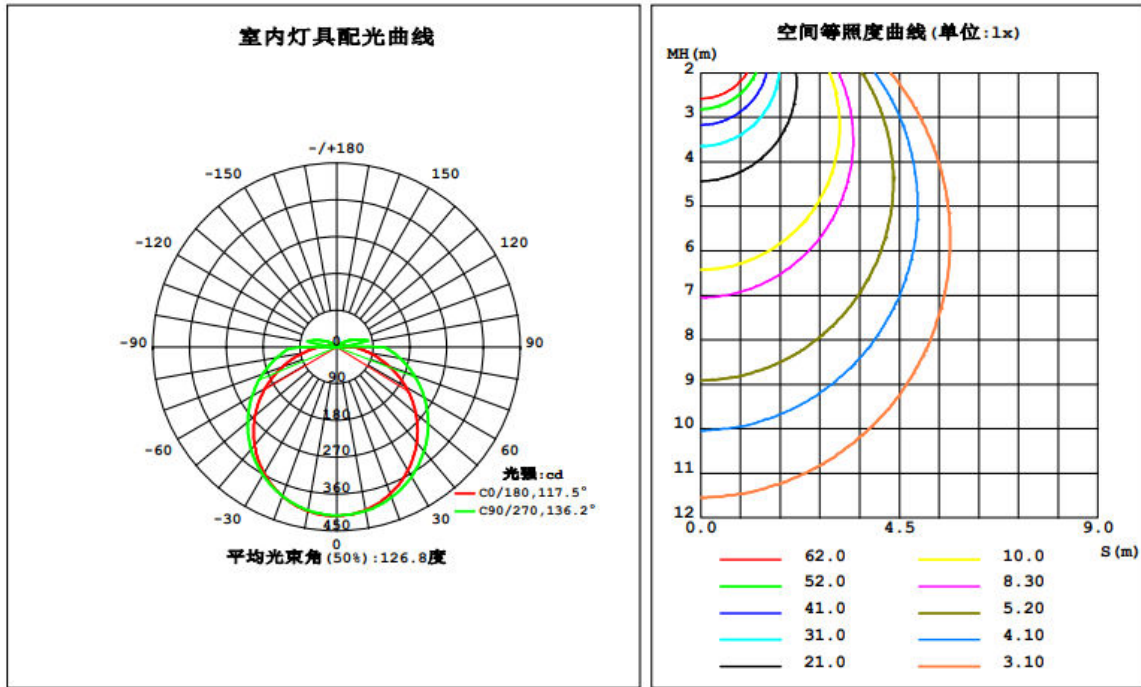

NSOL-16W-WH、NSOL-16W-WW

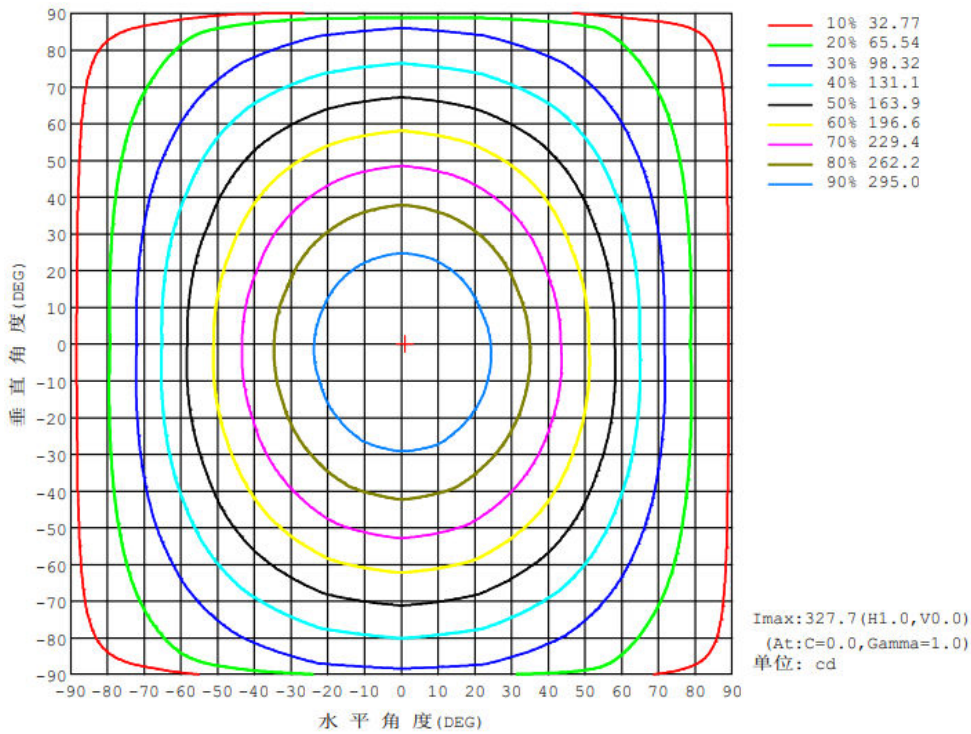

NSOL-22W-WH、NSOL-22W-WW

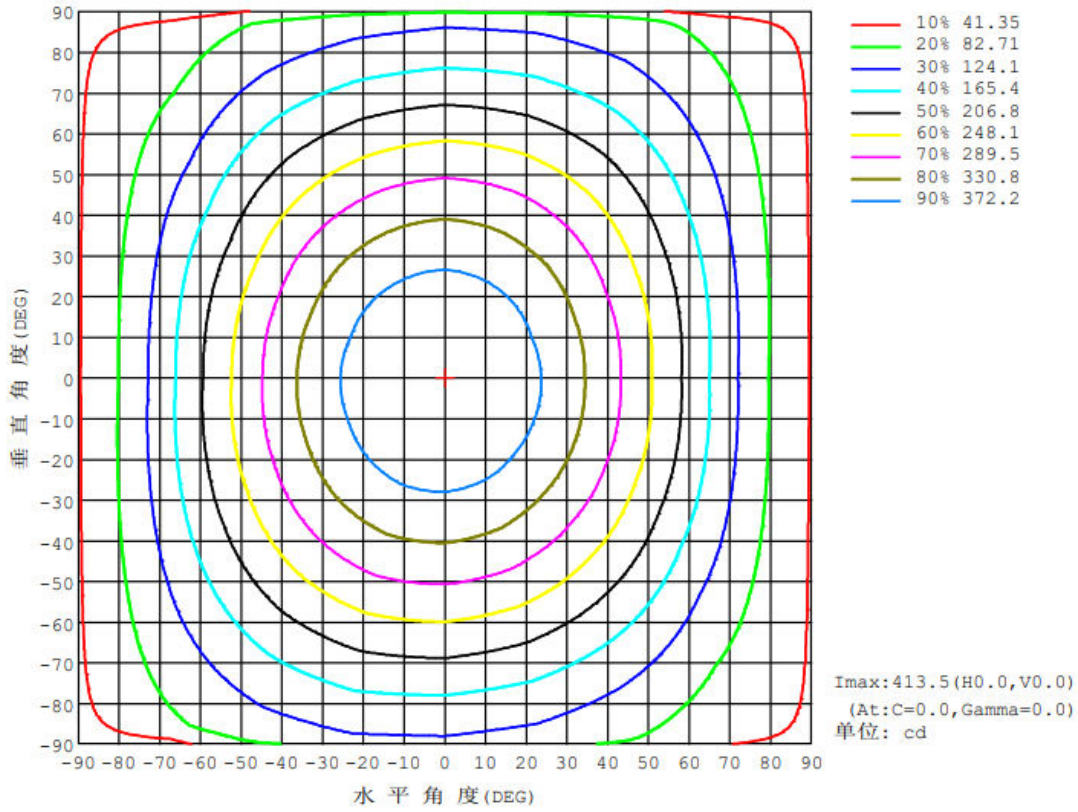

● Dimensions

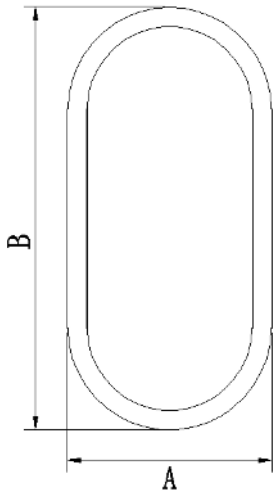

● Model	Diameter (mm)	A(mm)	B(mm)
16W	/	115± 1	215± 1
22W	/	145± 1	270± 1

● Instruction of wiring

1. Diagram of power supply wiring :

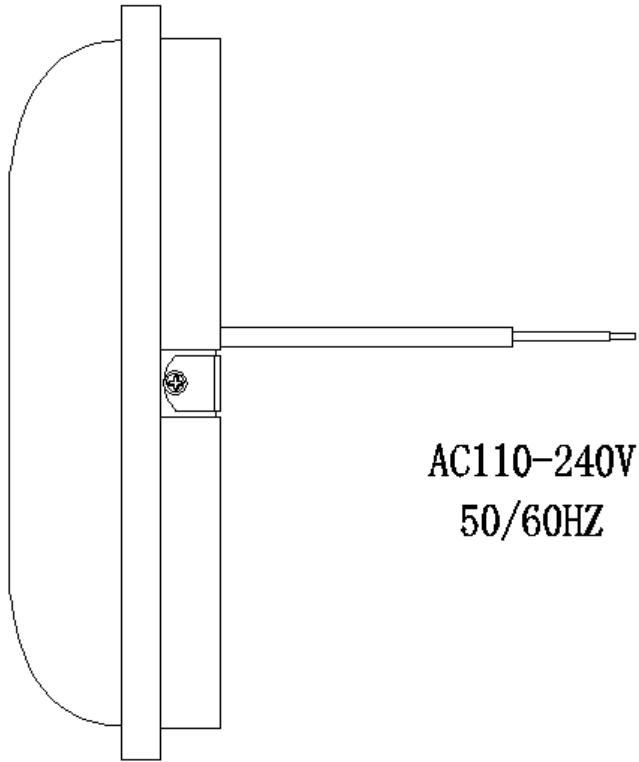

● Installation Instructions

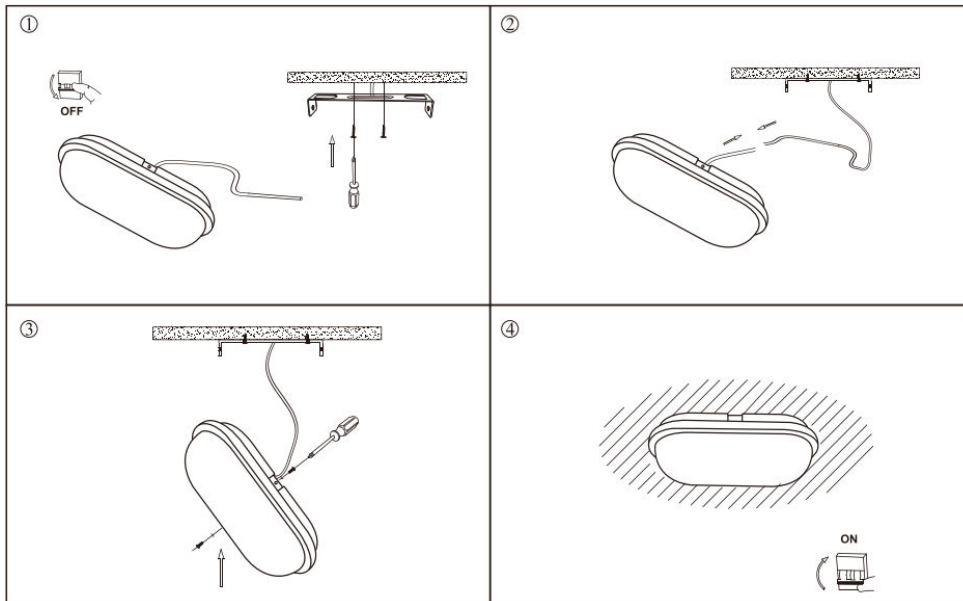

1. Fix the fixture with screw on ceiling;
2. Connect power and lamp;
3. Fix the lamp with fixture on ceiling by screw;
4. Finish installation and put the power on.

● Product Package

Packed in color box,20 PCS/ case

● Product Photo



● Packing size & Pictures:

Model	L (mm)	W (mm)	H (mm)
NSOL-16W-WH	220	70	120
NSOL-16W-WW	220	70	120
NSOL-22W-WH	275	85	150
NSOL-22W-WW	275	85	150

01.02.13.071.5482

内盒/220×70×120mm-250g灰底白+A5(120g芯) E坑-四色-覆光膜-16W-6500K



01.02.13.071.5483

内盒/220×70×120mm-250g灰底白+A5(120g芯) E坑-四色-覆光膜-16W-3000K



01.02.13.071.5480

内盒/275×85×150mm-250g灰底白+A5(120g芯) E坑-四色-覆光膜-22W-6500K



01.02.13.071.5481

内盒/275×85×150mm-250g灰底白+A5(120g芯) E坑-四色-覆光膜-22W-3000K



01.02.13.071.5926

内盒/275×85×150mm-250g灰底白+A5(120g芯) E坑-四色-覆光膜-22W-6500K



01.02.13.071.5927

内盒/275×85×150mm-250g灰底白+A5(120g芯) E坑-四色-覆光膜-22W-3000K



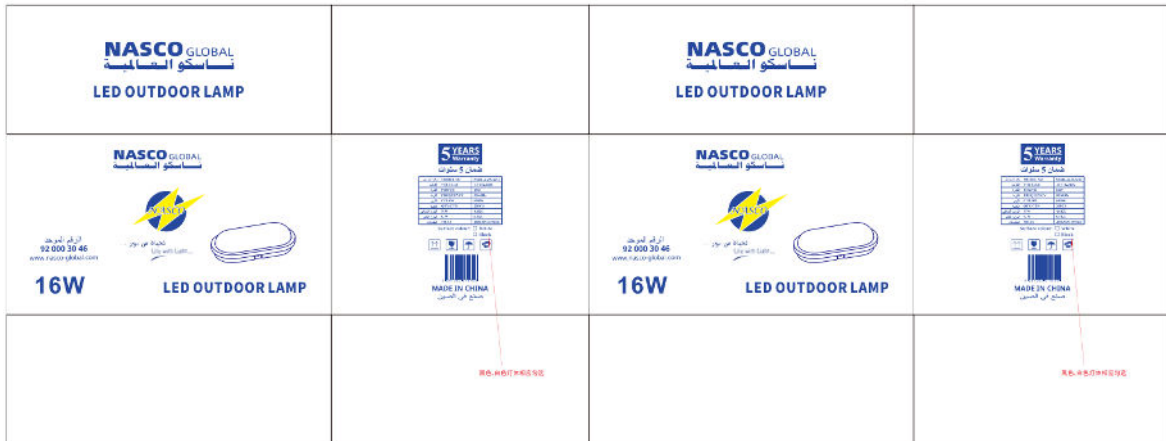

01.02.13.041.3782外箱/460×365×255mm-250g灰底白+535A(双120g芯) EB坑/四色-覆光膜-16W-6500K

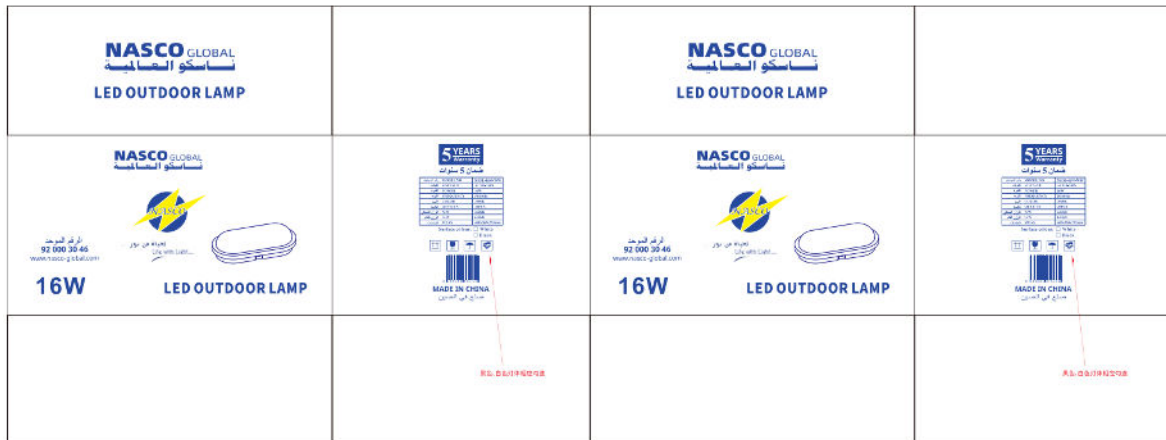

01.02.13.041.3783外箱/460×365×255mm-250g灰底白+535A(双120g芯) EB坑/四色-覆光膜-16W-3000K



01.02.13.041.3780外箱/570×440×315mm-250g灰底白+535A(双120g芯) EB坑/四色-覆光膜-22W-6500K

 <p>NASCO GLOBAL ناسكو العالمية LED OUTDOOR LAMP</p>		 <p>NASCO GLOBAL ناسكو العالمية LED OUTDOOR LAMP</p>	
 <p>NASCO GLOBAL ناسكو العالمية 22W LED OUTDOOR LAMP</p>	 <p>5 YEARS ضمان 5 سنوات</p> <p>MADE IN CHINA صنع في الصين</p>	 <p>NASCO GLOBAL ناسكو العالمية 22W LED OUTDOOR LAMP</p>	 <p>5 YEARS ضمان 5 سنوات</p> <p>MADE IN CHINA صنع في الصين</p>
	<p>EB.08346255</p>		<p>EB.08346255</p>

01.02.13.041.3781外箱/570×440×315mm-250g灰底白+535A(双120g芯) EB坑/四色-覆光膜-22W-3000K

 <p>NASCO GLOBAL ناسكو العالمية LED OUTDOOR LAMP</p>		 <p>NASCO GLOBAL ناسكو العالمية LED OUTDOOR LAMP</p>	
 <p>NASCO GLOBAL ناسكو العالمية 22W LED OUTDOOR LAMP</p>	 <p>5 YEARS ضمان 5 سنوات</p> <p>MADE IN CHINA صنع في الصين</p>	 <p>NASCO GLOBAL ناسكو العالمية 22W LED OUTDOOR LAMP</p>	 <p>5 YEARS ضمان 5 سنوات</p> <p>MADE IN CHINA صنع في الصين</p>
	<p>EB.08346255</p>		<p>EB.08346255</p>

● Attentions

1. Make sure the power is off before maintenance.
2. Clean the glass of diffuser of lamp regularly to maintain good light transmittance.
3. Clean the dust of the shell to maintain good heat dissipation performance.
4. Be careful not to use water or corrosive solution for cleaning, it is better to use a dry cloth.

● Warranty and After-sales Service

The period of guarantee is 5 years. Quality assurance is based on the correct storage, installation, use and maintenance of products. Due to improper installation and improper use of the product, the product is damaged beyond the scope of this warranty. During the warranty period, We will choose to repair, replace (spare parts)

with new products. Labor charges or material costs will be appropriately collected over the warranty period.

● Products Application Cases





The date listed in this file is for reference only, and the specific date should be subject to the specific products, if any change, sorry for no notice.