



## PRODUCT SPECIFICATION

Product Name: LED Panel Light

Product model: NS-5-S-65K NS-5-S-30K

DESCRIPTION : LED Panel Light



### ● Features

1. Using die-casting aluminum with good appearance for high class looking.
2. Built-in constant current driver for high efficiency and stability.
3. Imported SMD chip light source is adopted, with high light efficiency and long life.
4. Quick response time, the LED response time is nanosecond.
5. Environmental protection, no heavy metals and harmful gas.
6. Energy-saving, can save energy more 80% than traditional lights.
7. No flicker, start quickly, soft light, protect your eyes.
8. Easy to install and use.

### ● Technical Parameter

Model	NS-5-S
LED model	2835
LED Qty	36 PCS
Power	5W
Voltage	AC110-240 V

Working Frequency	50/60HZ
Power Efficiency	≥ 80%
Luminous Flux	330LM
Efficiency	65LM/W ± 10%
Power Factor	≥ 0.9
Colour Temperature	WH: 6500K(6020-7040) WW: 3000K(2875-3215)
CRI	Ra ≥ 80
Beam Angle	115°
Working Temperature	-20 to + 50 °C
Service life	30,000hr life 5yr warranty

● Relative Spectral Energy Distribution

NS-5-S-65K

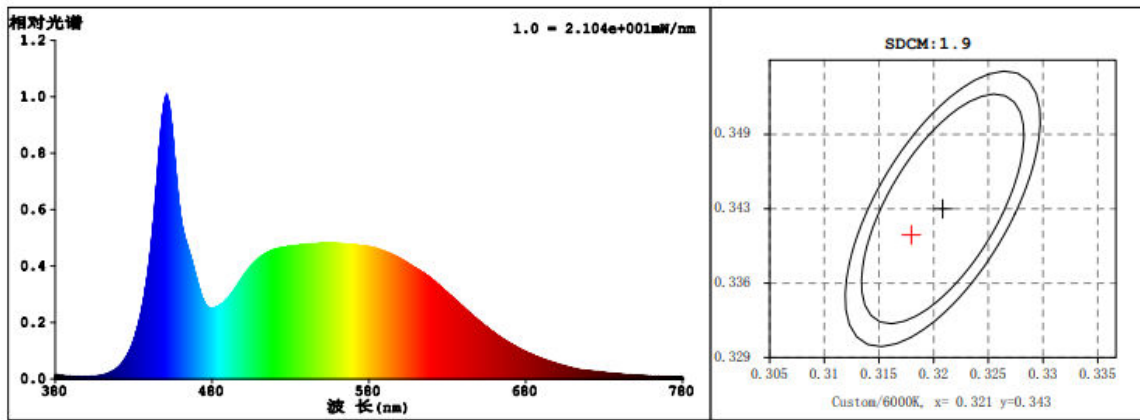

NS-5-S-30K

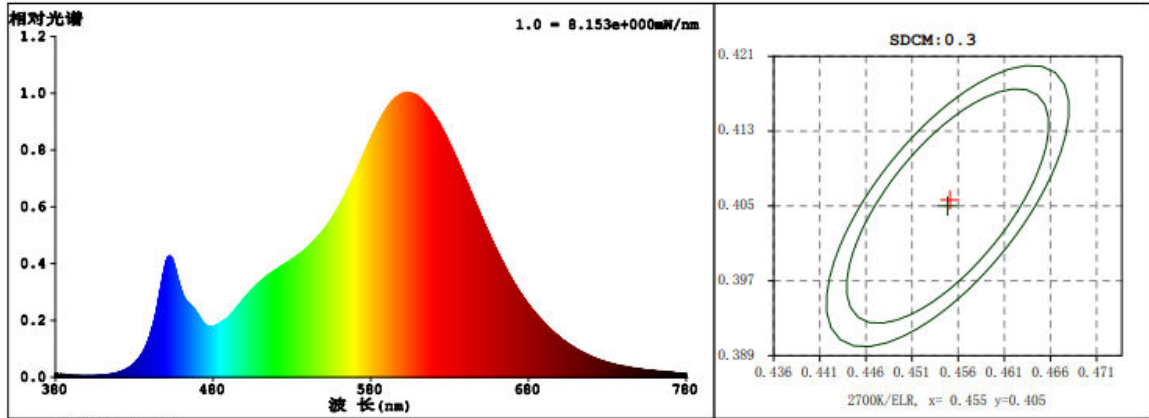

● Optical characteristic curve

NS-5-S

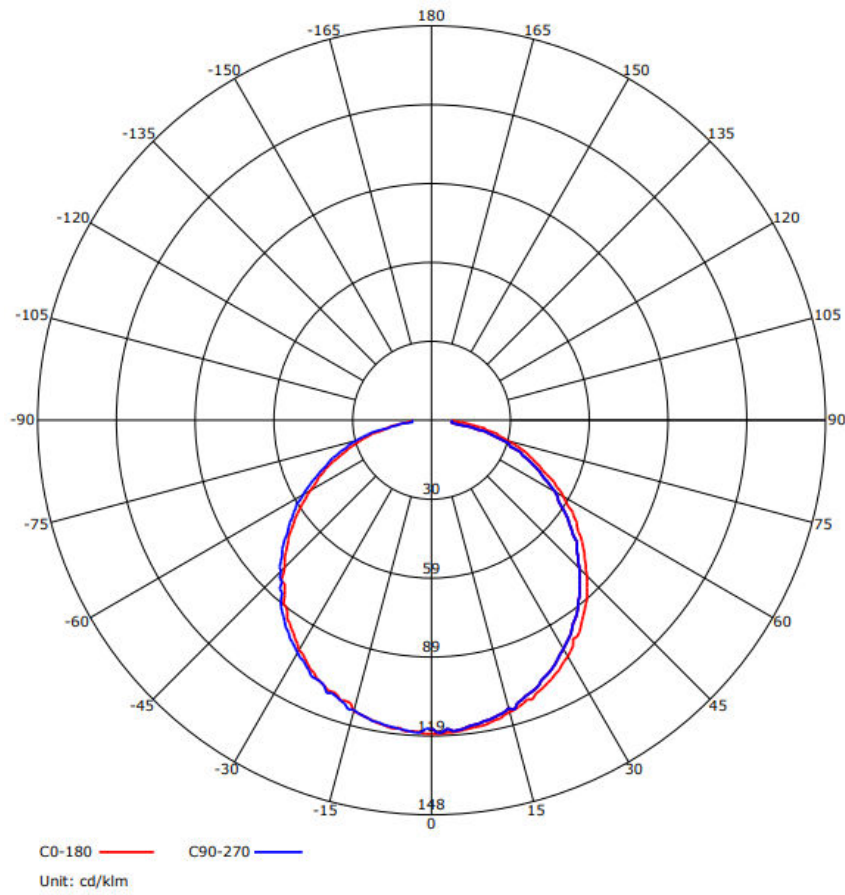

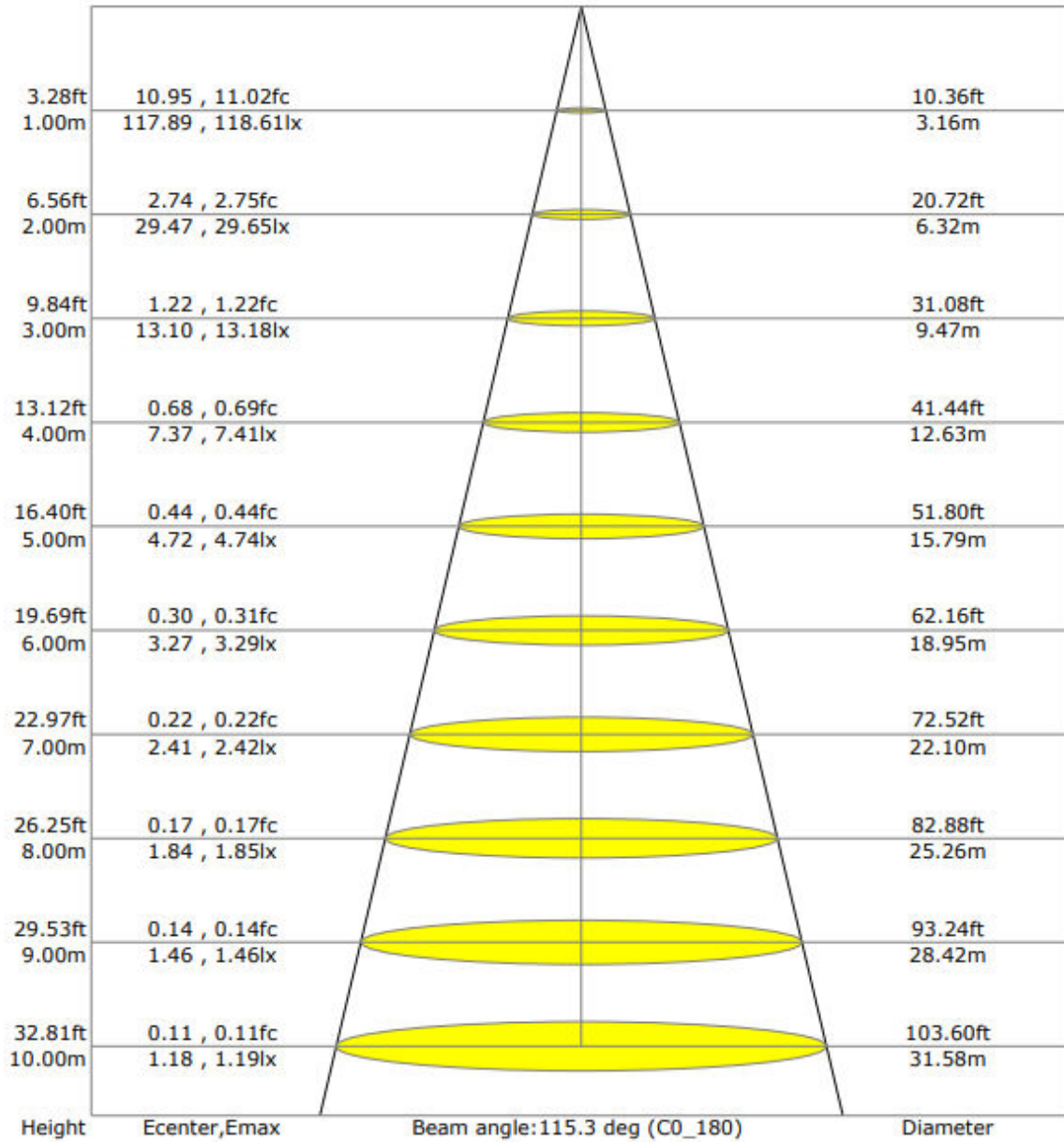

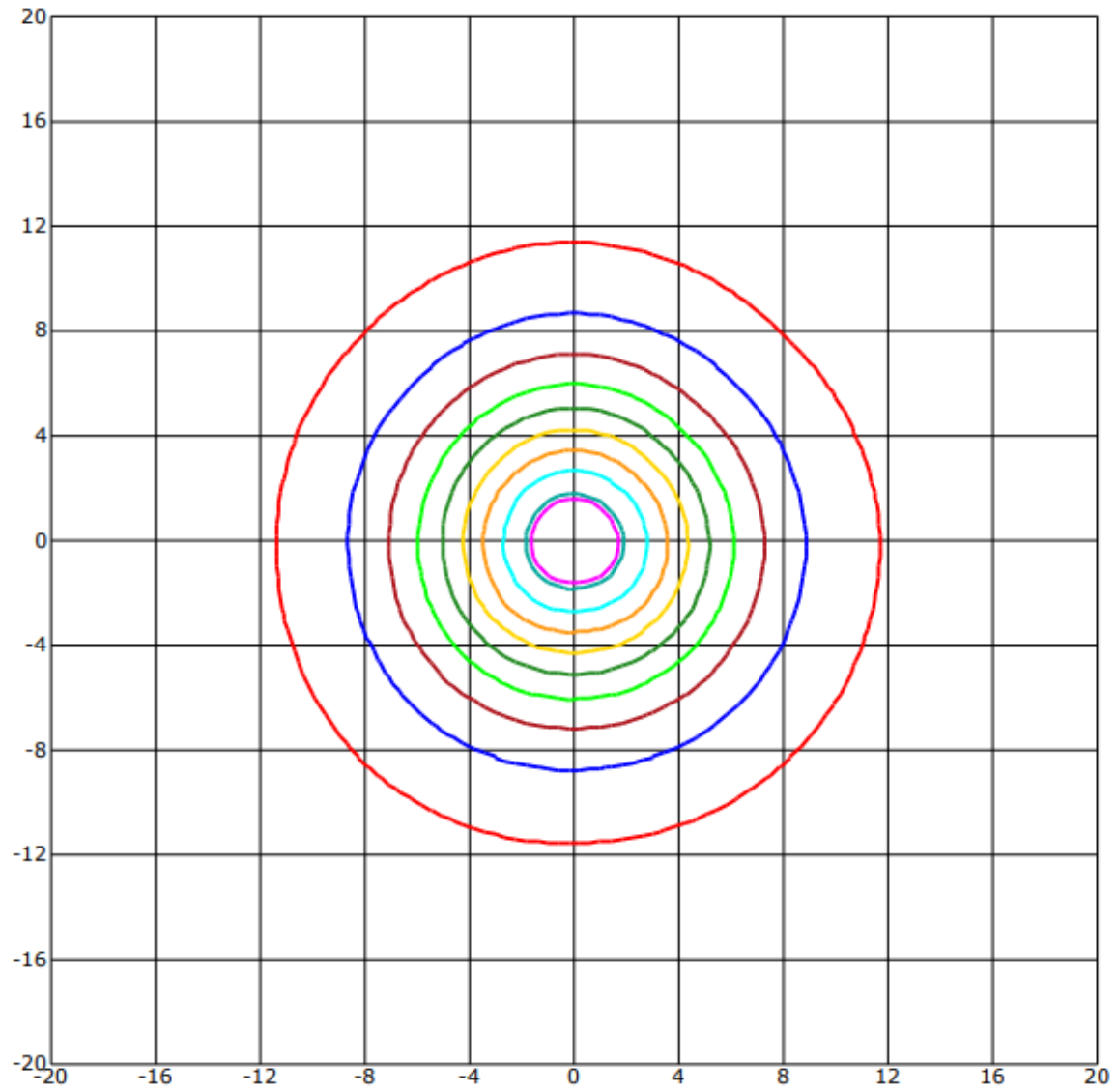

Unit of illumination:lx      Height of plane:8.0(m)/26.25(ft)

- |               |               |
|---------------|---------------|
| 1.704(1%Emax) | 0.926(1%Emax) |
| 1.667(1%Emax) | 0.741(1%Emax) |
| 1.482(1%Emax) | 0.556(0%Emax) |
| 1.297(1%Emax) | 0.37(0%Emax)  |
| 1.111(1%Emax) | 0.185(0%Emax) |

- Dimensions

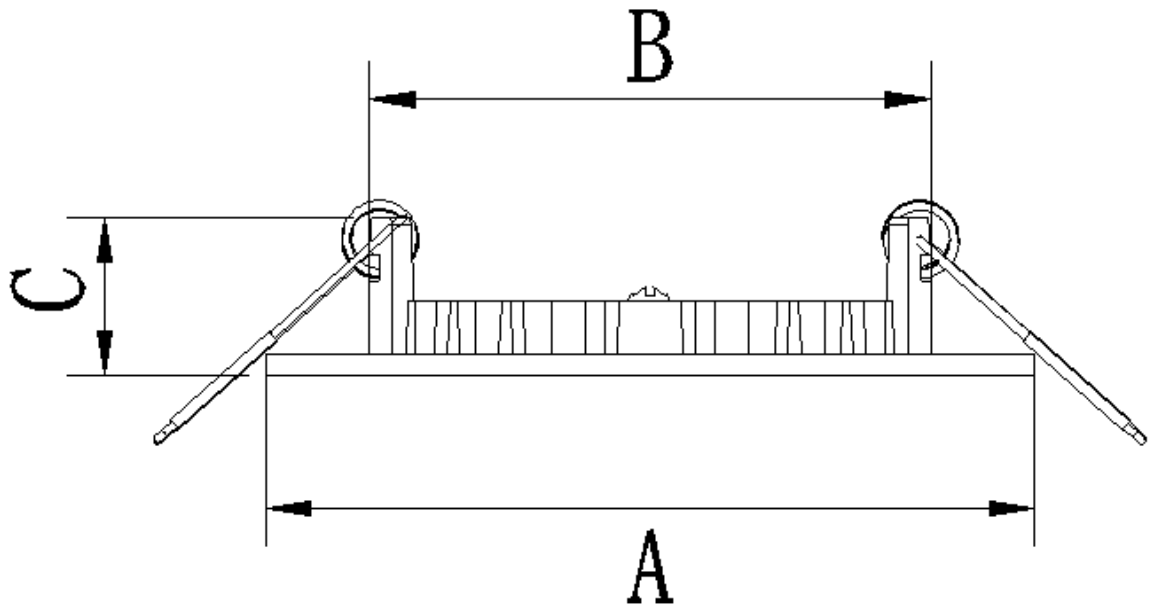

- | Model  | Diameter (mm) | A(mm) | B(mm) | C(mm) |
|--------|---------------|-------|-------|-------|
| NS-5-S | /             | 90± 1 | 70± 1 | 19±1  |

- Instruction of wiring

1. Diagram of power supply wiring :

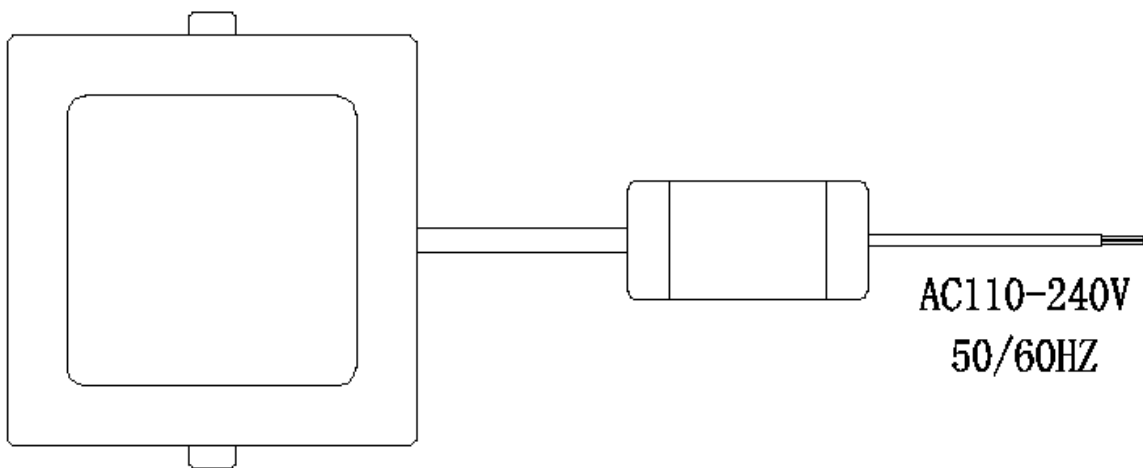

## ● Installation Instructions

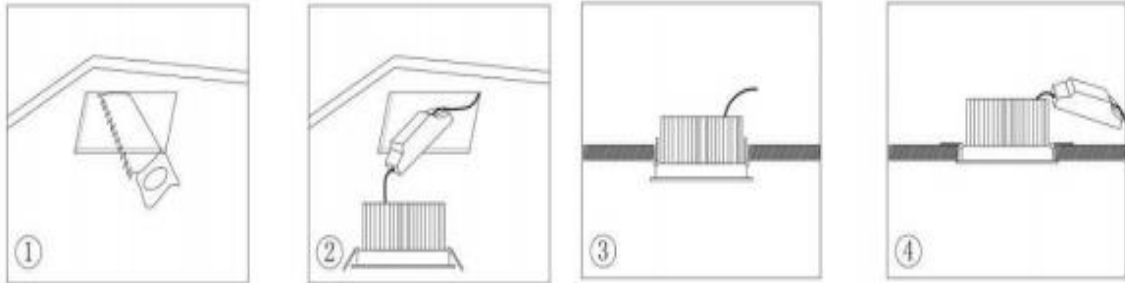

1. Make a hole of the right size in the ceiling;
2. Connect power and lamp;
3. Attach the spring-loaded lamp to the ceiling;
4. Finish installation and put the power on.

## ● Product Package

Packed in color box,100 PCS/ case

## ● Product Photo



## ● Packing size & Pictures:

Model	L (mm)	W (mm)	H (mm)
NS-5-S-65K	120	98	40
NS-5-S-30K	120	98	40

编码: 01.02.13.071.4678

内盒/120\*98\*40mm

250g灰底白+A2(100g芯) E坑/四色/覆光膜/NS-5-S-65K

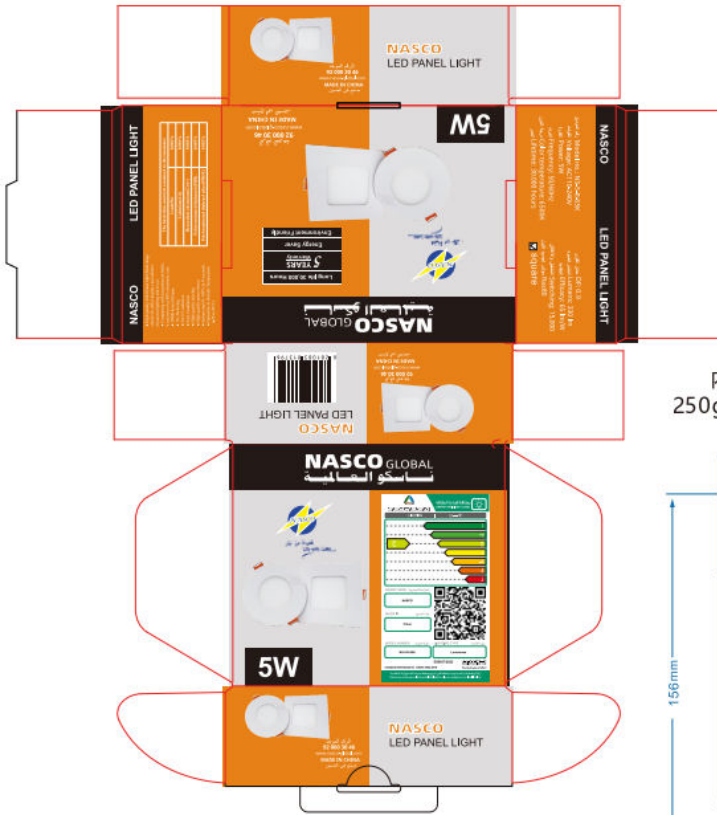

编码: 01.02.13.170.1877

内卡/166x156mm/

250g灰底白+A2(100g芯) E坑/内孔 74\*74mm

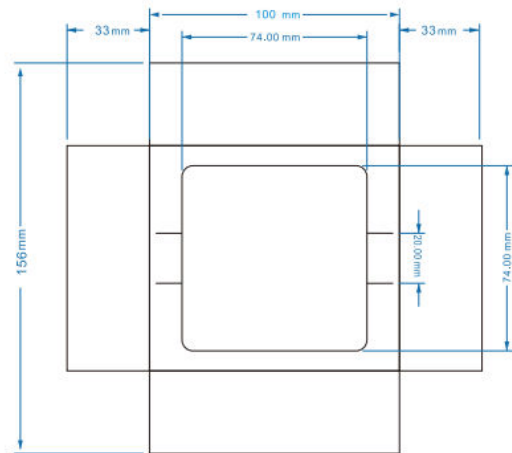



编码: 01.02.13.071.4677

内盒/ 120\*98\*40mm

250g灰底白+A2(100g芯) E坑/四色/覆光膜/NS-5-S-30K

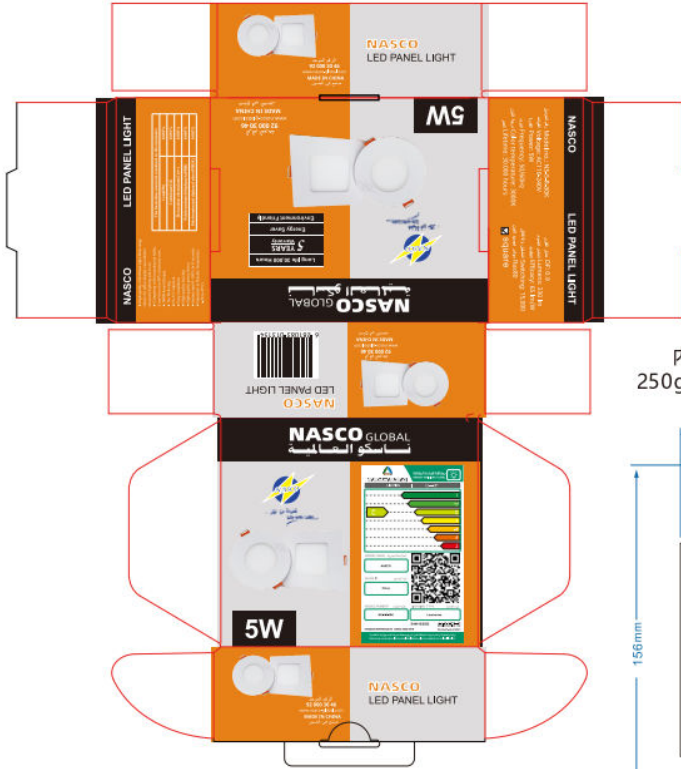

编码: 01.02.13.170.1877

内卡/166 x156 mm/

250g灰底白+A2(100g芯) E坑/内孔 74\*74mm

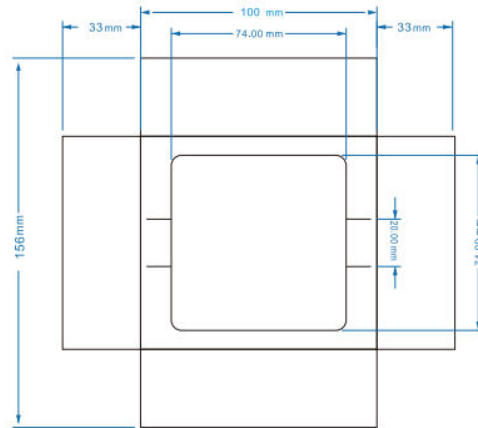

01.02.13.041.3508外箱/430x250x505mm/250g灰底白+535A(双120g芯) EB坑/四色/覆光膜/NS-5-S-65K-V1

<p><b>NASCO GLOBAL</b> ناسكو العالمية</p> <p><b>LED panel Light</b></p>	<p><b>NASCO GLOBAL</b> ناسكو العالمية</p> <p><b>LED panel Light</b></p>	<p><b>NASCO GLOBAL</b> ناسكو العالمية</p> <p><b>LED panel Light</b></p>	<p><b>NASCO GLOBAL</b> ناسكو العالمية</p> <p><b>LED panel Light</b></p>																																																						
<p><b>NASCO GLOBAL</b> ناسكو العالمية</p> <p>حياة في نور... Life with Light...</p>  <p><b>5W LED panel light</b></p>	<p><b>5 YEARS</b> Warranty ضمان 5 سنوات</p> <table border="1"> <tr><td>نموذج</td><td>MODEL NO</td><td>NS-5-S-65K</td></tr> <tr><td>القدرة</td><td>VOLTAGE</td><td>AC110V-240V</td></tr> <tr><td>القدرة</td><td>POWER</td><td>5W</td></tr> <tr><td>اللون</td><td>BEHOLDEN</td><td>6000K</td></tr> <tr><td>اللون</td><td>COLOR</td><td>6500K</td></tr> <tr><td>التيار</td><td>QUANTITY</td><td>100PCS</td></tr> <tr><td>الوزن الصافي</td><td>NET WT</td><td>24.8KG</td></tr> <tr><td>الوزن الكلي</td><td>G.W</td><td>13.80KG</td></tr> <tr><td>القياسات</td><td>MEAS</td><td>430x250x505mm</td></tr> </table>  <p>MADE IN CHINA صنع في الصين</p>	نموذج	MODEL NO	NS-5-S-65K	القدرة	VOLTAGE	AC110V-240V	القدرة	POWER	5W	اللون	BEHOLDEN	6000K	اللون	COLOR	6500K	التيار	QUANTITY	100PCS	الوزن الصافي	NET WT	24.8KG	الوزن الكلي	G.W	13.80KG	القياسات	MEAS	430x250x505mm	<p><b>NASCO GLOBAL</b> ناسكو العالمية</p> <p>حياة في نور... Life with Light...</p>  <p><b>5W LED panel light</b></p>	<p><b>5 YEARS</b> Warranty ضمان 5 سنوات</p> <table border="1"> <tr><td>نموذج</td><td>MODEL NO</td><td>NS-5-S-65K</td></tr> <tr><td>القدرة</td><td>VOLTAGE</td><td>AC110V-240V</td></tr> <tr><td>القدرة</td><td>POWER</td><td>5W</td></tr> <tr><td>اللون</td><td>BEHOLDEN</td><td>6000K</td></tr> <tr><td>اللون</td><td>COLOR</td><td>6500K</td></tr> <tr><td>التيار</td><td>QUANTITY</td><td>100PCS</td></tr> <tr><td>الوزن الصافي</td><td>NET WT</td><td>24.8KG</td></tr> <tr><td>الوزن الكلي</td><td>G.W</td><td>13.80KG</td></tr> <tr><td>القياسات</td><td>MEAS</td><td>430x250x505mm</td></tr> </table>  <p>MADE IN CHINA صنع في الصين</p>	نموذج	MODEL NO	NS-5-S-65K	القدرة	VOLTAGE	AC110V-240V	القدرة	POWER	5W	اللون	BEHOLDEN	6000K	اللون	COLOR	6500K	التيار	QUANTITY	100PCS	الوزن الصافي	NET WT	24.8KG	الوزن الكلي	G.W	13.80KG	القياسات	MEAS	430x250x505mm
نموذج	MODEL NO	NS-5-S-65K																																																							
القدرة	VOLTAGE	AC110V-240V																																																							
القدرة	POWER	5W																																																							
اللون	BEHOLDEN	6000K																																																							
اللون	COLOR	6500K																																																							
التيار	QUANTITY	100PCS																																																							
الوزن الصافي	NET WT	24.8KG																																																							
الوزن الكلي	G.W	13.80KG																																																							
القياسات	MEAS	430x250x505mm																																																							
نموذج	MODEL NO	NS-5-S-65K																																																							
القدرة	VOLTAGE	AC110V-240V																																																							
القدرة	POWER	5W																																																							
اللون	BEHOLDEN	6000K																																																							
اللون	COLOR	6500K																																																							
التيار	QUANTITY	100PCS																																																							
الوزن الصافي	NET WT	24.8KG																																																							
الوزن الكلي	G.W	13.80KG																																																							
القياسات	MEAS	430x250x505mm																																																							
<p style="text-align: right;">激活 转到</p>																																																									



● **Attentions**

1. Make sure the power is off before maintenance.
2. Clean the lamp diffuser regularly to maintain good light transmittance.
3. Clean the dust of the shell to maintain good heat dissipation performance.
4. Be careful not to use water or corrosive solution for cleaning, it is better to use a dry cloth.

● **Warranty and After-sales Service**

The period of guarantee is 5 years. Quality assurance is based on the correct storage, installation, use and maintenance of products. Due to improper installation and improper use of the product, the product is damaged beyond the scope of this warranty. During the warranty period, We will choose to repair, replace (spare parts) with new products. Labor charges or material costs will be appropriately collected over the warranty period.

● Products Application Cases



The date listed in this file is for reference only, and the specific date should be subject to the specific products, if any change, sorry for no notice.