



PRODUCT SPECIFICATION

Product Name: LED Spot Light

Product model: NSDL-7B-65K NSDL-7B-40K NSDL-7B-30K

DESCRIPTION : LED Spot Light (COB)



● Features

1. Using die-casting aluminum with good appearance for high class looking.
2. Built-in constant current driver for high efficiency and stability.
3. Adopt imported COB as light source with high light efficiency and long lifespan.
4. Quick response time, the LED response time is nanosecond.
5. Environmental protection, no heavy metals and harmful gas.
6. Energy-saving, can save energy more 80% than traditional lights.
7. No flicker, start quickly, soft light, protect your eyes.
8. Easy to install and use.

● Technical Parameter

Model	NSDL-7B
LED model	COB 1311
LED Qty	1 PCS
Power	7 W
Voltage	AC110-240 V

Working Frequency	50/60HZ
Power Efficiency	≥ 80%
Luminous Flux	455LM
Efficiency	65LM/W ± 10%
Power Factor	≥ 0.9
Colour Temperature	WH : 6500K(6020-7040) NW: 4000K(3710-4260) WW: 3000K(2875-3215)
CRI	Ra ≥ 80
Bean Angle	80°
Working Temperature	-20 to + 50 °C
Service life	30,000hr life 5yr warranty

● Relative Spectral Energy Distribution

NSDL-7B-65K

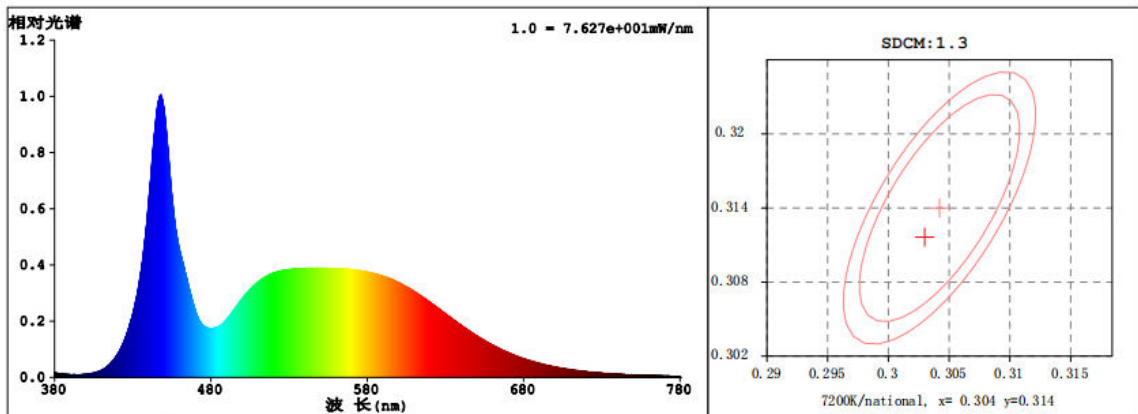

NSDL-7B-30K

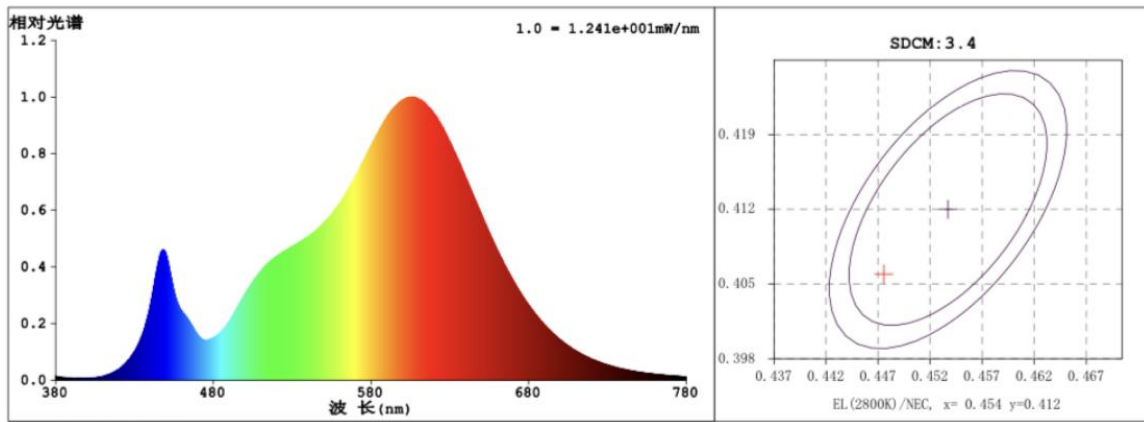

● Optical characteristic curve

NSDL-7B

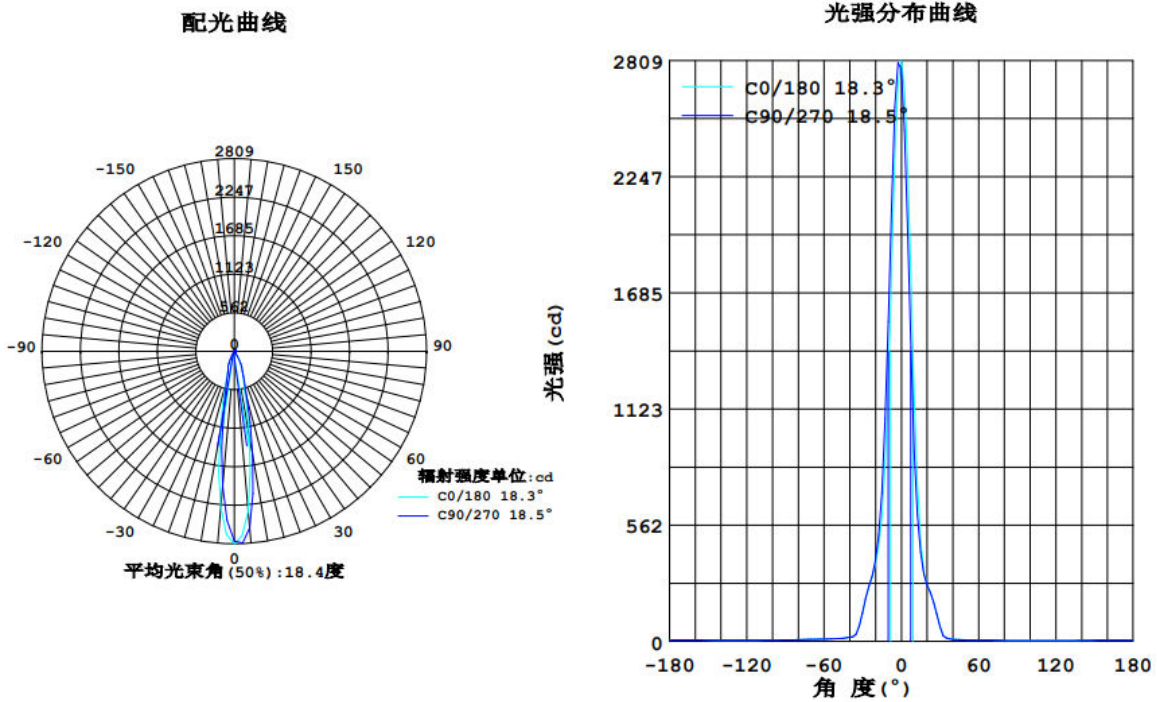

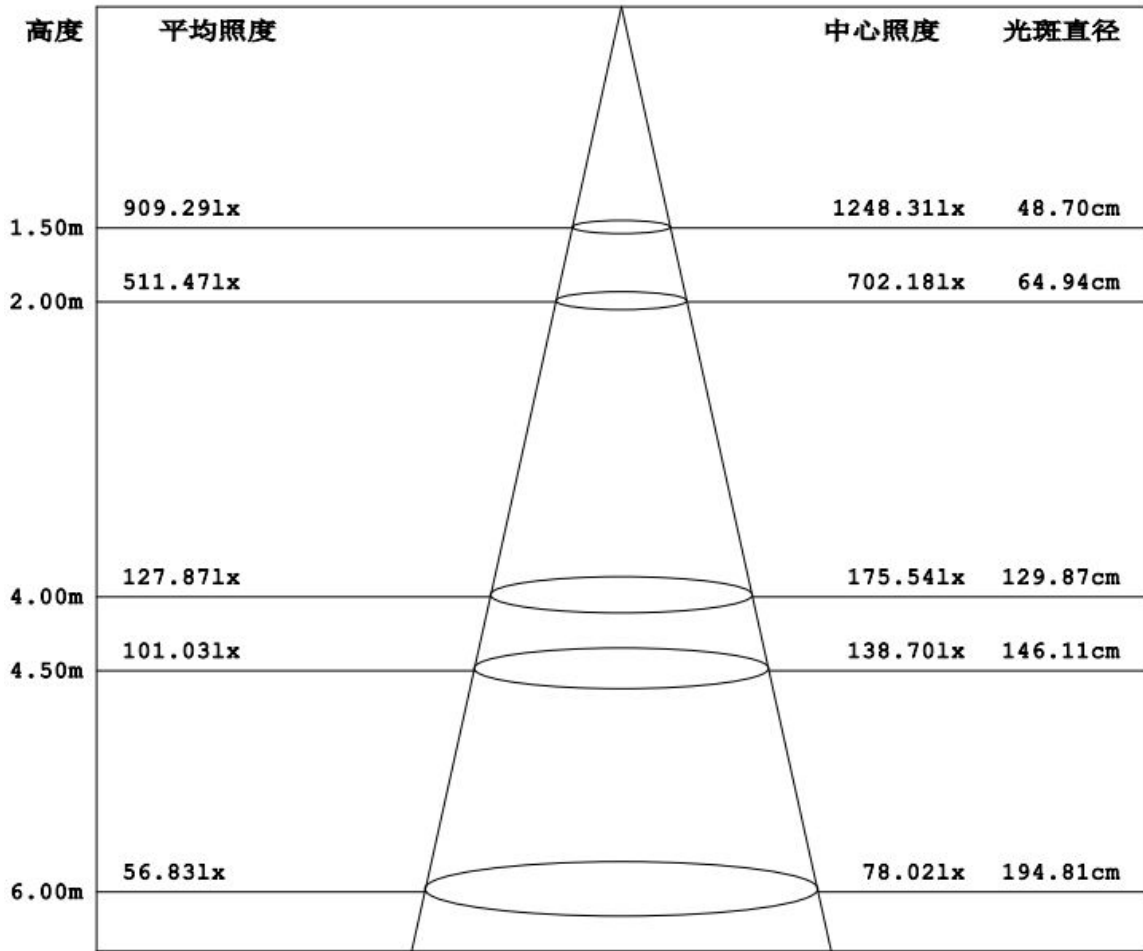

光束角:18.4度

光强单位: cd

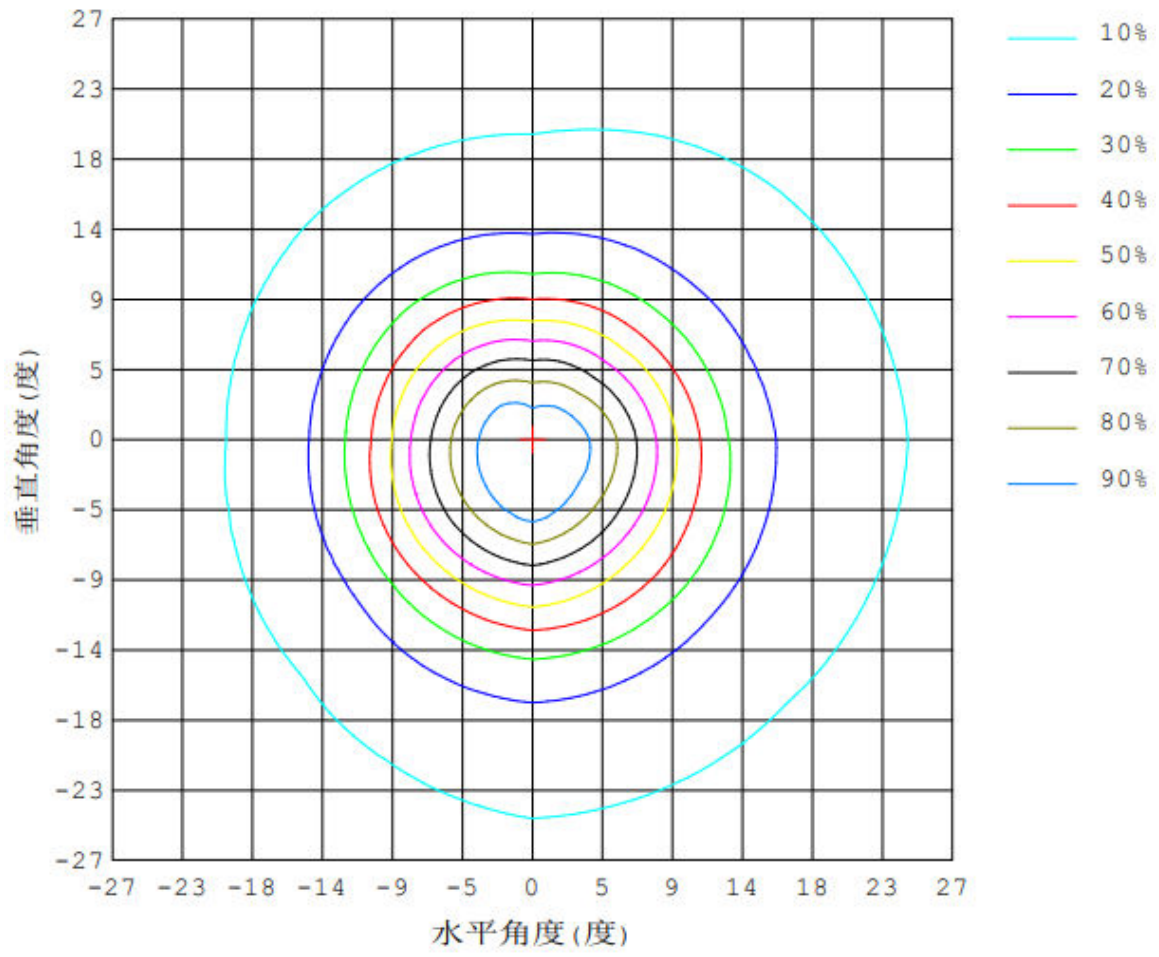

- Dimensions

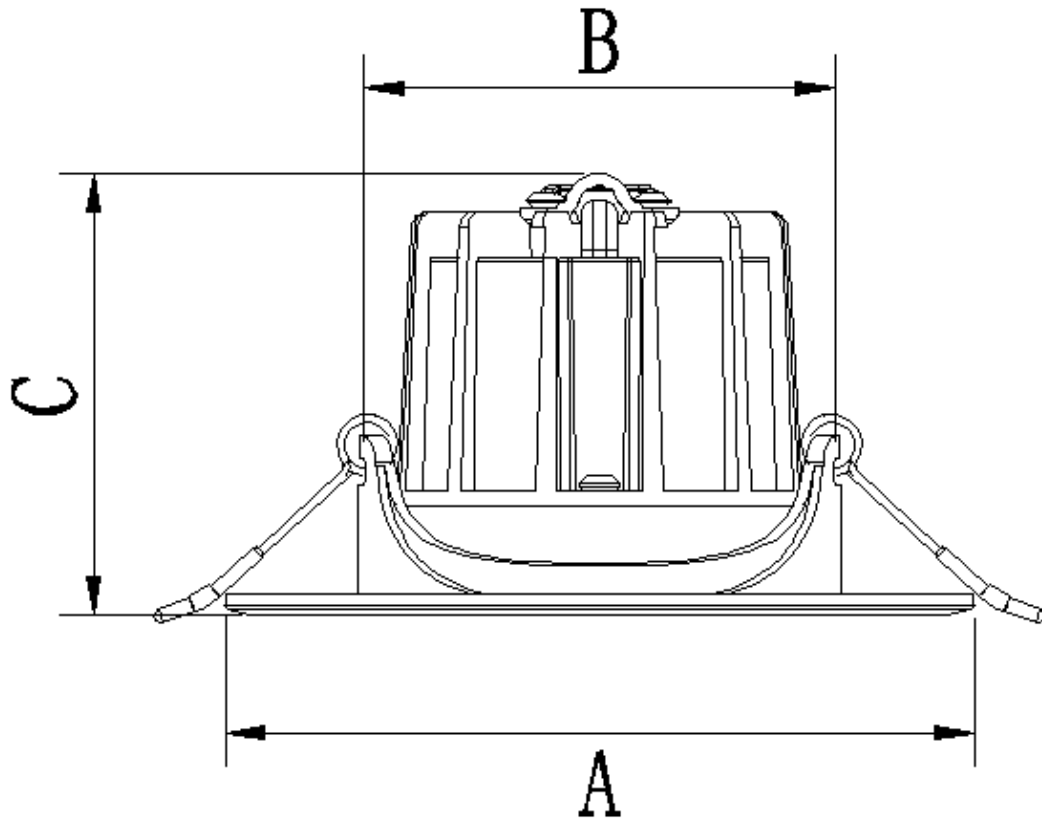

- Model Diameter (mm) A(mm) B(mm) C(mm)
- 7W / 100± 1 70± 1 60±1

- Instruction of wiring

1. Diagram of power supply wiring :

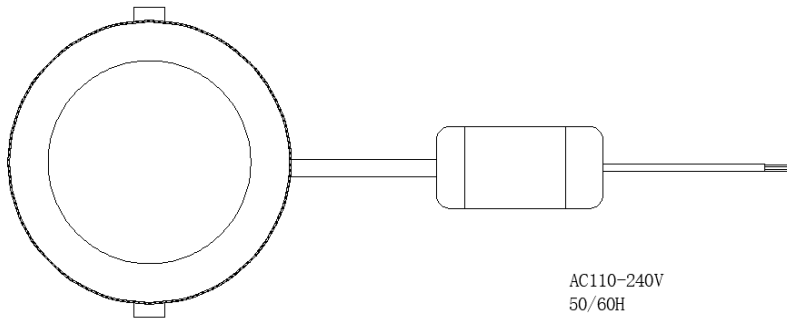

AC110-240V
50/60H

● Installation Instructions

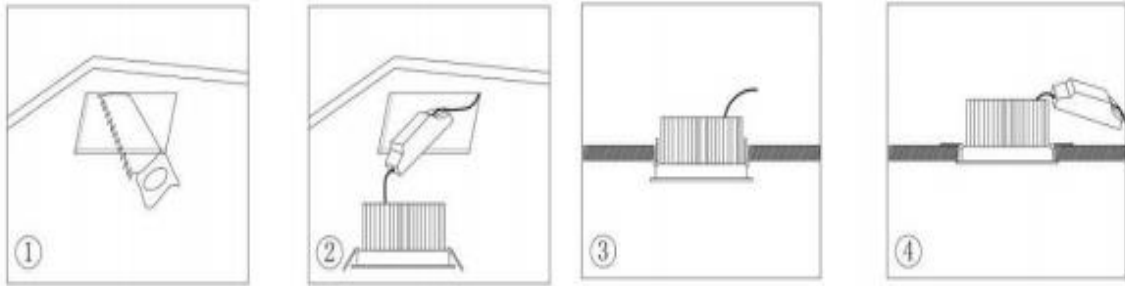

1. Make a hole of the right size in the ceiling;
2. Connect power and lamp;
3. Attach the spring-loaded lamp to the ceiling;
4. Finish installation and put the power on.

● Product Package

Packed in color box,50 PCS/ case

● Product Photo



● Packing size & Pictures:

Model	L (mm)	W (mm)	H (mm)
NSDL-7B-65K	105	105	65
NSDL-7B-40K	105	105	65

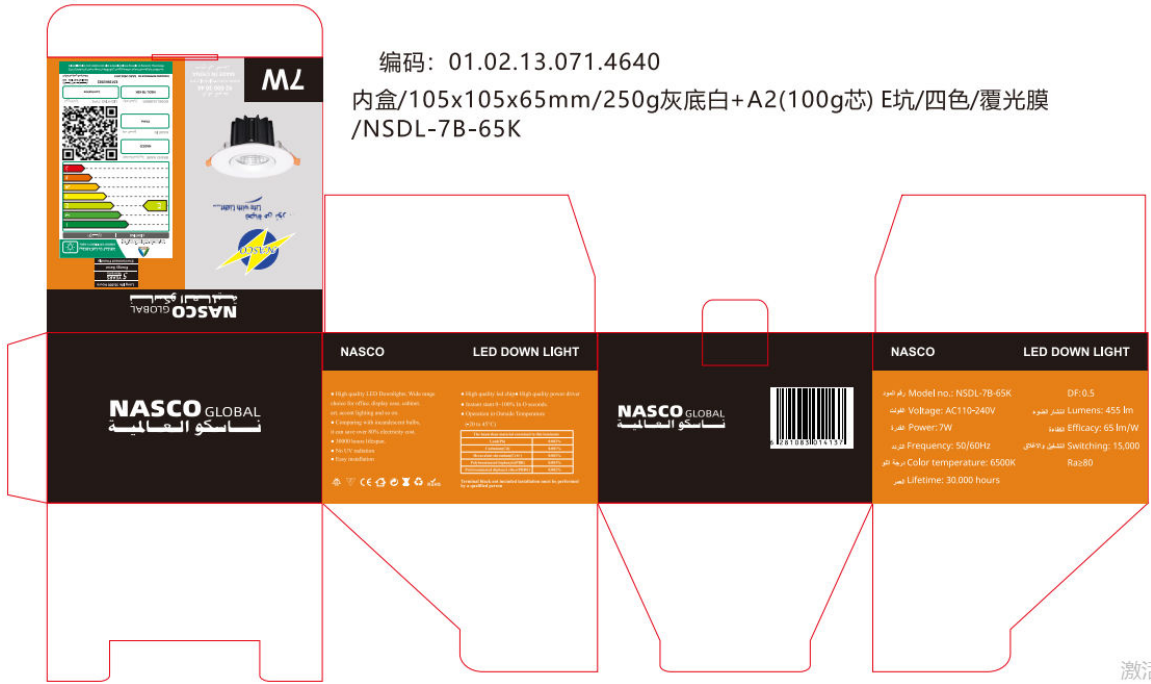

激光



激光

01.02.13.041.3411外箱/340x225x545mm/250g灰底白+535A(双120g芯) EB坑/四色/覆光膜/NSDL-7B-65K

<p>NASCO GLOBAL ناسكو العالمية LED DOWN LIGHT</p>		<p>NASCO GLOBAL ناسكو العالمية LED DOWN LIGHT</p>																																																							
<p>NASCO GLOBAL ناسكو العالمية</p>  <p>لحياة من نور... Life with Light...</p>  <p>الرقم الموحد 92 000 30 46 www.nasco-global.com</p> <p>7W LED DOWN LIGHT</p>	<p>5 YEARS Warranty ضمان 5 سنوات</p> <table border="1" data-bbox="609 514 787 619"> <tr><td>رقم الموديل</td><td>MODEL NO</td><td>NSDL-7B-65K</td></tr> <tr><td>الجهد</td><td>VOLTAGE</td><td>AC 110-240V</td></tr> <tr><td>القدرة</td><td>POWER</td><td>7W</td></tr> <tr><td>التردد</td><td>FREQUENCY</td><td>50/60Hz</td></tr> <tr><td>اللون</td><td>COLOR</td><td>4500K</td></tr> <tr><td>الكفاءة</td><td>EFFECTIVENESS</td><td>50PCS</td></tr> <tr><td>وزن المنتج</td><td>N.W</td><td>4.35KG</td></tr> <tr><td>وزن الكرتون</td><td>G.W</td><td>10.38KG</td></tr> <tr><td>القياسات</td><td>MEAS</td><td>340x225x545mm</td></tr> </table>   <p>6 9281083041414</p> <p>MADE IN CHINA صنع في الصين</p>	رقم الموديل	MODEL NO	NSDL-7B-65K	الجهد	VOLTAGE	AC 110-240V	القدرة	POWER	7W	التردد	FREQUENCY	50/60Hz	اللون	COLOR	4500K	الكفاءة	EFFECTIVENESS	50PCS	وزن المنتج	N.W	4.35KG	وزن الكرتون	G.W	10.38KG	القياسات	MEAS	340x225x545mm	<p>NASCO GLOBAL ناسكو العالمية</p>  <p>لحياة من نور... Life with Light...</p>  <p>الرقم الموحد 92 000 30 46 www.nasco-global.com</p> <p>7W LED DOWN LIGHT</p>	<p>5 YEARS Warranty ضمان 5 سنوات</p> <table border="1" data-bbox="1177 514 1356 619"> <tr><td>رقم الموديل</td><td>MODEL NO</td><td>NSDL-7B-65K</td></tr> <tr><td>الجهد</td><td>VOLTAGE</td><td>AC 110-240V</td></tr> <tr><td>القدرة</td><td>POWER</td><td>7W</td></tr> <tr><td>التردد</td><td>FREQUENCY</td><td>50/60Hz</td></tr> <tr><td>اللون</td><td>COLOR</td><td>4500K</td></tr> <tr><td>الكفاءة</td><td>EFFECTIVENESS</td><td>50PCS</td></tr> <tr><td>وزن المنتج</td><td>N.W</td><td>4.35KG</td></tr> <tr><td>وزن الكرتون</td><td>G.W</td><td>10.38KG</td></tr> <tr><td>القياسات</td><td>MEAS</td><td>340x225x545mm</td></tr> </table>   <p>6 9281083041414</p> <p>MADE IN CHINA صنع في الصين</p>	رقم الموديل	MODEL NO	NSDL-7B-65K	الجهد	VOLTAGE	AC 110-240V	القدرة	POWER	7W	التردد	FREQUENCY	50/60Hz	اللون	COLOR	4500K	الكفاءة	EFFECTIVENESS	50PCS	وزن المنتج	N.W	4.35KG	وزن الكرتون	G.W	10.38KG	القياسات	MEAS	340x225x545mm
رقم الموديل	MODEL NO	NSDL-7B-65K																																																							
الجهد	VOLTAGE	AC 110-240V																																																							
القدرة	POWER	7W																																																							
التردد	FREQUENCY	50/60Hz																																																							
اللون	COLOR	4500K																																																							
الكفاءة	EFFECTIVENESS	50PCS																																																							
وزن المنتج	N.W	4.35KG																																																							
وزن الكرتون	G.W	10.38KG																																																							
القياسات	MEAS	340x225x545mm																																																							
رقم الموديل	MODEL NO	NSDL-7B-65K																																																							
الجهد	VOLTAGE	AC 110-240V																																																							
القدرة	POWER	7W																																																							
التردد	FREQUENCY	50/60Hz																																																							
اللون	COLOR	4500K																																																							
الكفاءة	EFFECTIVENESS	50PCS																																																							
وزن المنتج	N.W	4.35KG																																																							
وزن الكرتون	G.W	10.38KG																																																							
القياسات	MEAS	340x225x545mm																																																							

01.02.13.041.3145 外箱/340x225x545mm/250g灰底白+535A(双120g芯) EB坑/四色/覆光膜/NSDL-7B-30K



● **Attentions**

1. Make sure the power is off before maintenance.
2. Clean the glass of diffuser of lamp regularly to maintain good light transmittance.
3. Clean the dust of the shell to maintain good heat dissipation performance.
4. Be careful not to use water or corrosive solution for cleaning, it is better to use a dry cloth.

● **Warranty and After-sales Service**

The period of guarantee is 5 years. Quality assurance is based on the correct storage, installation, use and maintenance of products. Due to improper installation and improper use of the product, the product is damaged beyond the scope of this warranty. During the warranty period, We will choose to repair, replace (spare parts)

with new products. Labor charges or material costs will be appropriately collected over the warranty period.

● Products Application Cases





The date listed in this file is for reference only, and the specific date should be subject to the specific products, if any change, sorry for no notice.