

LED BATTERY LIGHT (FOR PROJECT) DESCRIPTION

NS-BL27W



Specification

1 . Lighting Design Related Detail Sketches



2 . Dimension

Size:600x75mm

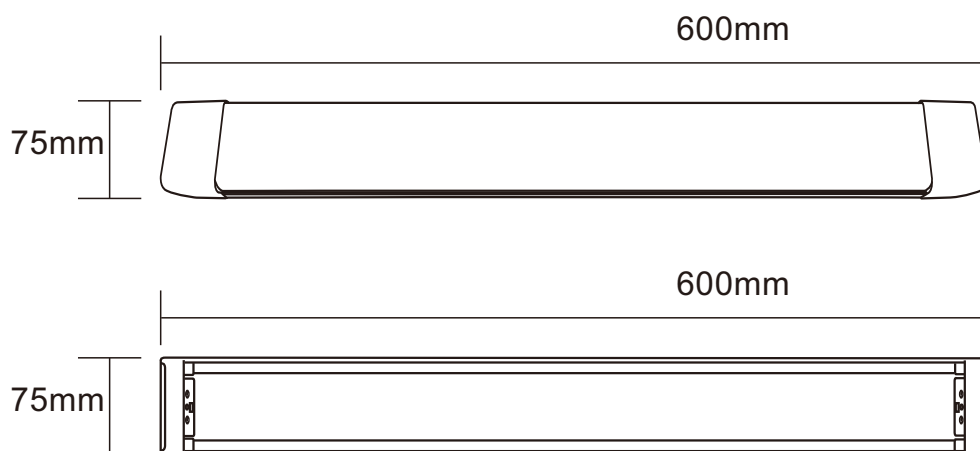

3 . Description

- High efficiency, low energy consumption.
- Good quality beam.
- Long life span 30000 hours.
- Ecological. The waste can be recycled.No pollution and mercury.



4 . Technical parameter

Specification

PRODUCT SPECIFICATION

Dimension:	600x75mm
LED package:	2835
LED quantity:	150PCS
Beam angle:	120°
Color temperature:	3000K/6500K
CRI:	≥80
Lifetime:	30,000 hours
Operating temp:	Ta=-25 to 60°C (Tc max=70°C)
IP Rating:	IP20
Warranty:	5 Years

PERFORMANCE DATA

Power consumption:	27W
Frequency range:	50Hz/60Hz
Supply voltage:	AC220-240V
Output current:	550mA
Power factor:	>0.9
Luminous flux:	2500

5 . Light Distribution Curve

Luminous Intensity Distribution Curve

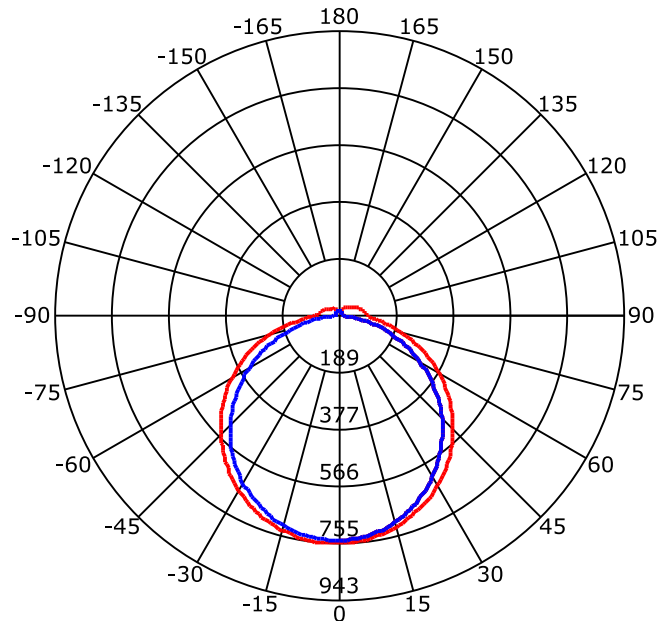

Beam Angle(50%) C0-180,C90-270: 123.4 deg,112.5 deg

C0-180 ——— C90-270 ———



6. Illumination Cone Curve

Specification

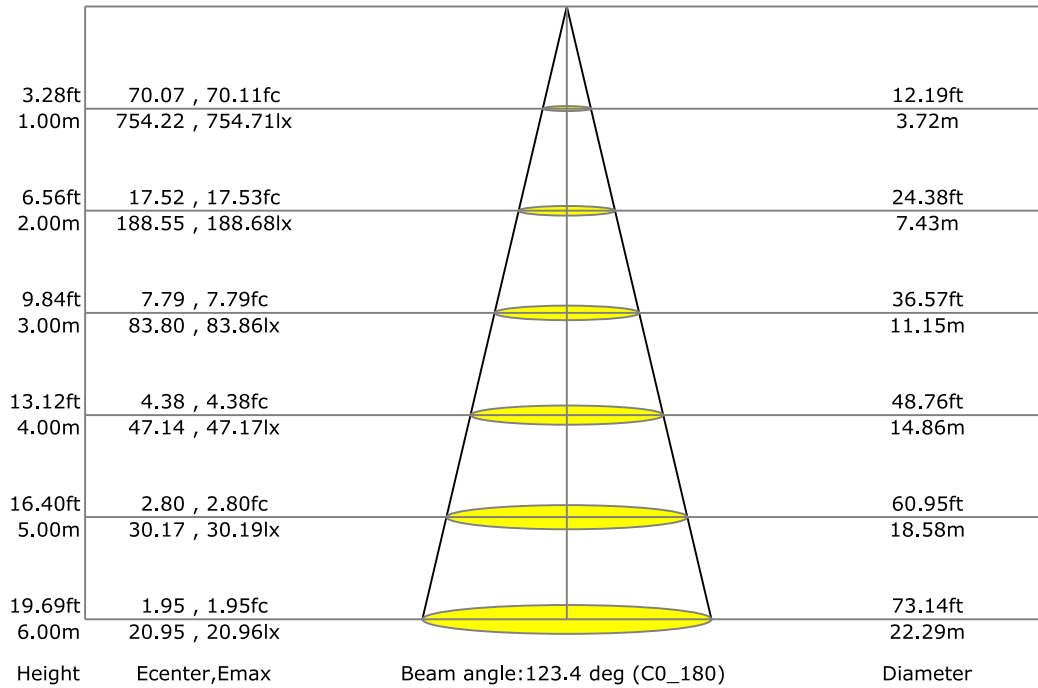

7. Horizontal Isophotes Curve

Horizontal Absolute Isophotes Curve

Height of calculation: 6 m, Illumination in the vertical of Lamp: 20.96 lx

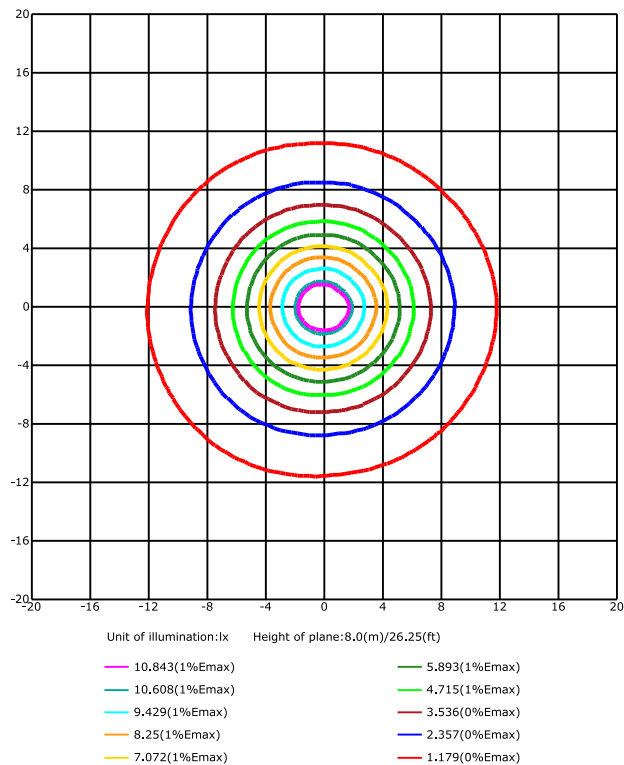



Specification

8 Color Information

(Y)

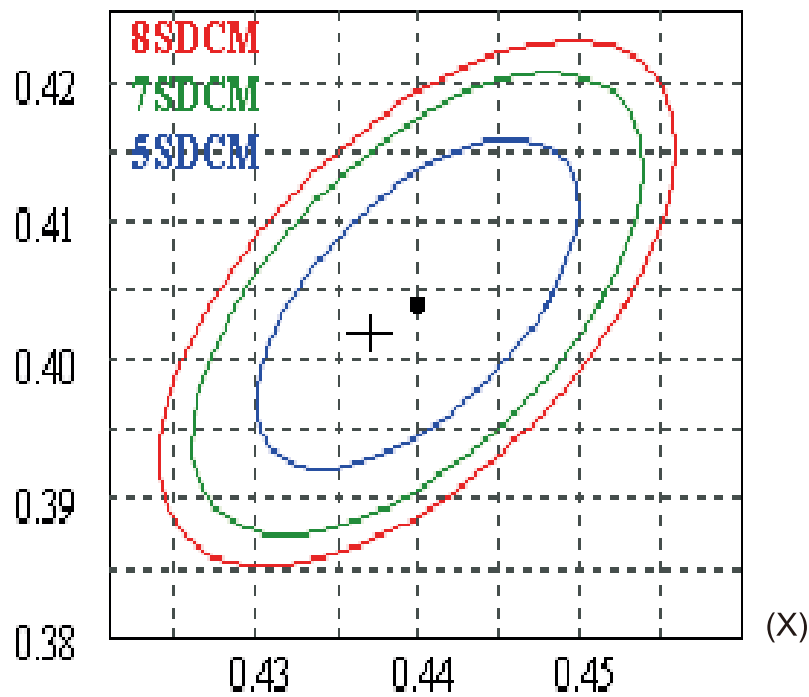

3000K

$x=0.440$ $y=0.403$

Color Consistency - Initial

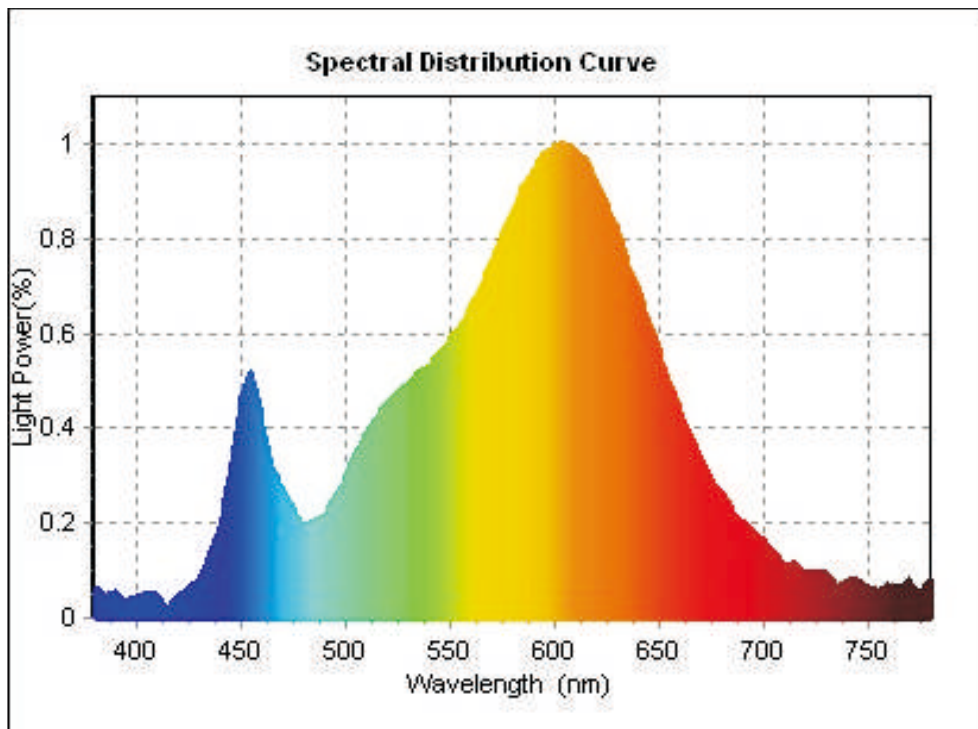

Spectral Power Distribution



Color Information

Specification

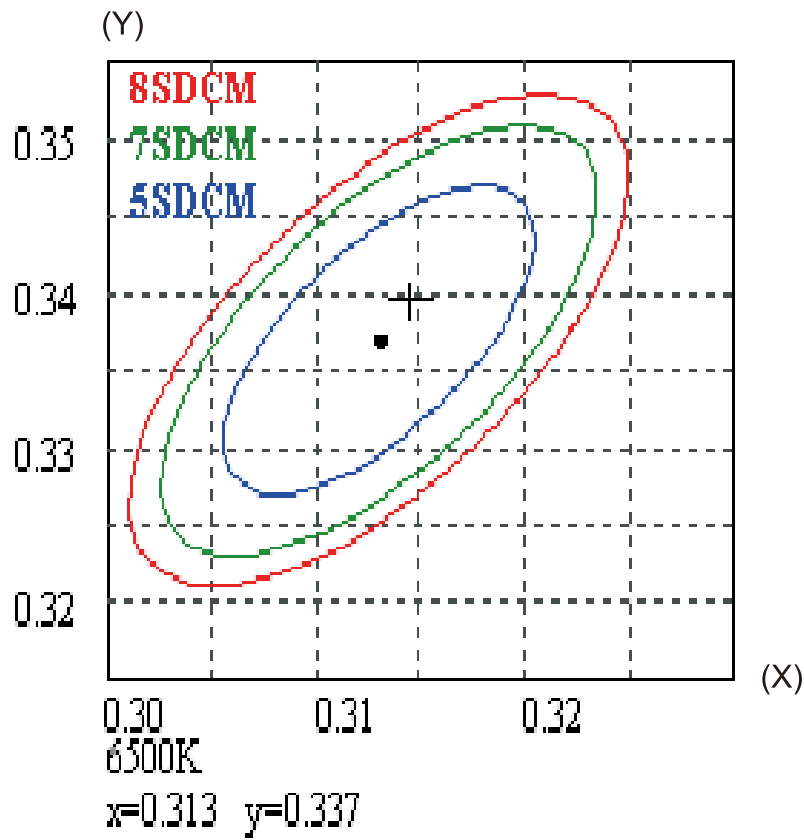

Color Consistency - Initial

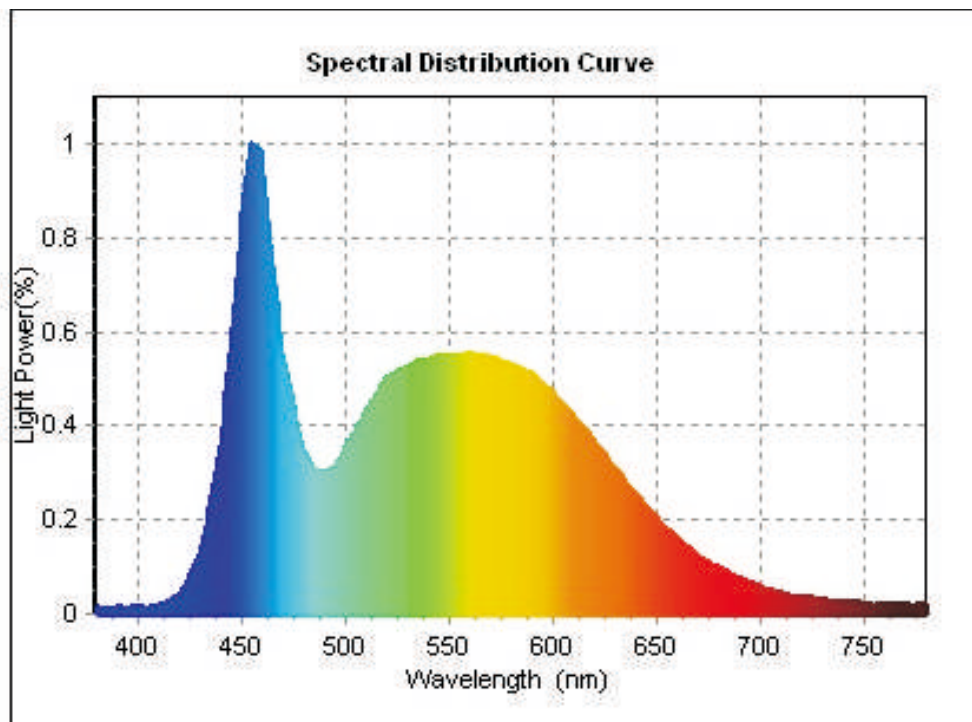

Spectral Power Distribution



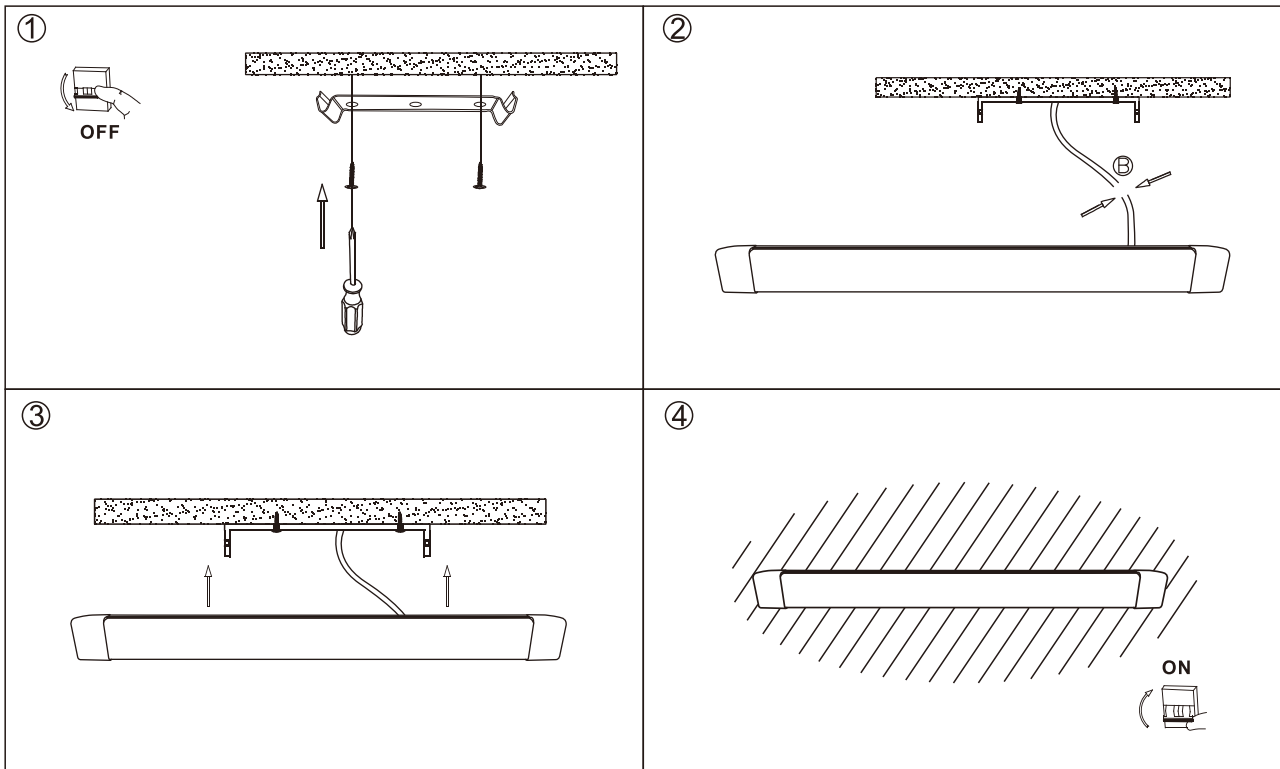



9 . Installation



Pay Attention:

1. It's better be installed in the open place in order to heat dissipation.
2. The dust on the lamp should be cleaned termly to ensure good dissipation.
3. Please Don't install it outdoor!

10 .Notes

-  Do not attempt to install or use a fixture until you read and understand the installation instructions and safety label.
-  Fixtures have line voltage risk of shock and no user serviceable parts. Do not attempt to open them.
-  Do not hot swap fixtures. Ensure that power to the series is off before connecting or disconnecting individual fixtures.
-  Do not use a fixture if the lens, housing, or power cables are damaged.
-  Do not use a fixture for any voltage for which it is not rated. Do not exceed the specified voltage and current input for any fixture.
-  Do not use the eye to see the light source directly.