

# LED OUTDOOR LAMP (FOR PROJECT) DESCRIPTION

NS606-16W



Specification

## 1 . Lighting Design Related Detail Sketches



## 2 . Dimension

Size:215x115x65mm

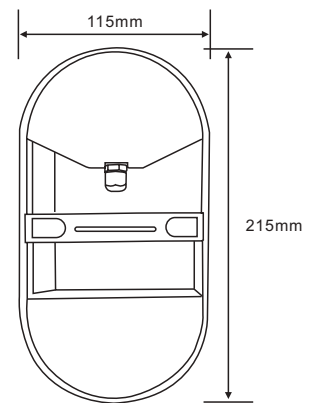
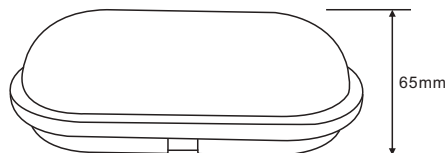
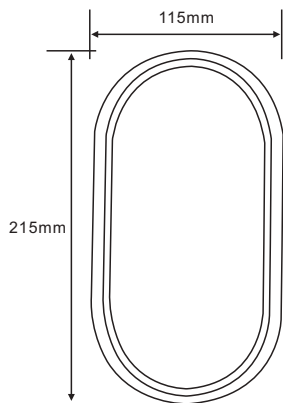

## 3 . Description

- High efficiency, low energy consumption.
- Good quality beam.
- Long life span 30000 hours.
- Ecological. The waste can be recycled.No pollution and mercury.



## 4 . Technical parameter

### Specification

#### PRODUCT SPECIFICATION

<b>Dimension:</b>	215x115xH65mm
<b>LED package:</b>	2835
<b>LED quantity:</b>	80PCS
<b>Beam angle:</b>	120°
<b>Color temperature:</b>	6500K-7000K
<b>CRI:</b>	≥80
<b>Lifetime:</b>	30,000 hours
<b>Operating temp:</b>	Ta=-25 to 60°C (Tc max=70°C)
<b>IP Rating:</b>	IP65
<b>Warranty:</b>	5 Years

#### PERFORMANCE DATA

<b>Power consumption:</b>	16W
<b>Frequency range:</b>	50Hz/60Hz
<b>Supply voltage:</b>	AC220-240V
<b>Output current:</b>	300mA
<b>Power factor:</b>	>0.9
<b>Luminous flux:</b>	1600

## 5 . Light Distribution Curve

### Distribution Curve of Meridian

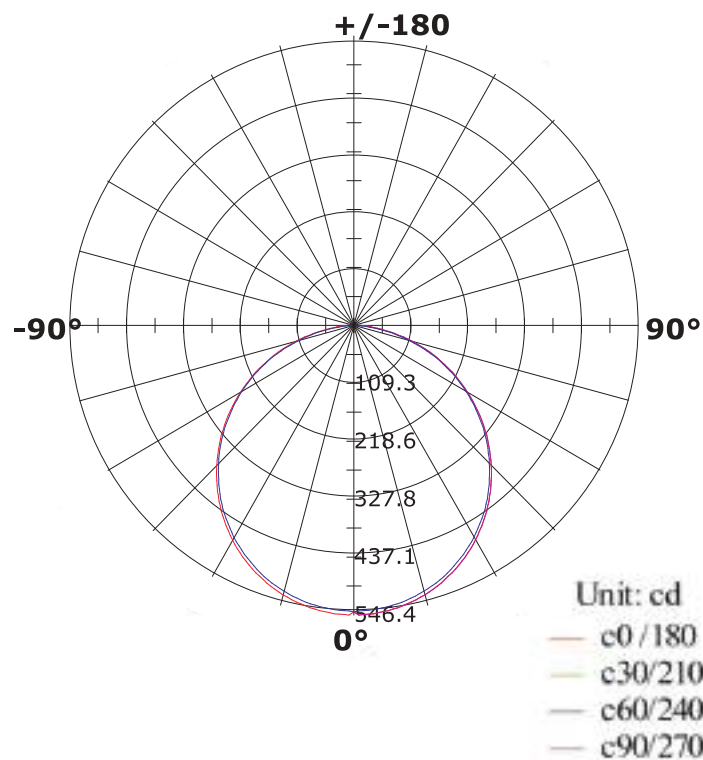



## 6. Illumination Cone Curve

### Specification

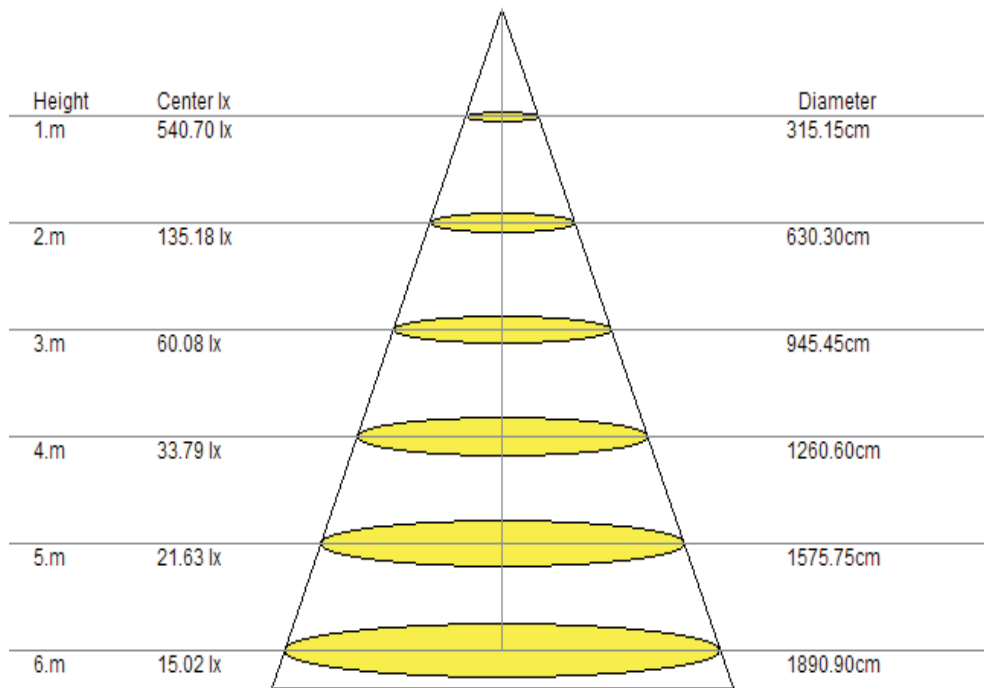

## 7. Horizontal Isophotes Curve

### Horizontal Absolute Isophotes Curve

Height of calculation: 6 m, Illumination in the vertical of Lamp: 15.02 lx

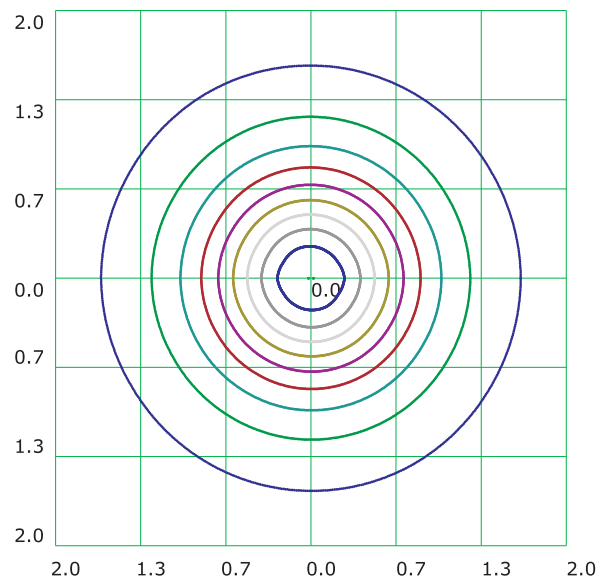

Height: 1 m

- (10%): 54.6lx      (20%): 109.3lx      (30%): 163.9lx      (40%): 218.6lx
- (50%): 273.2lx      (60%): 327.9lx      (70%): 382.5lx      (80%): 437.1lx
- (90%): 491.8lx      (100%): 545.9lx



## Specification

# 8 Color Information

(Y)

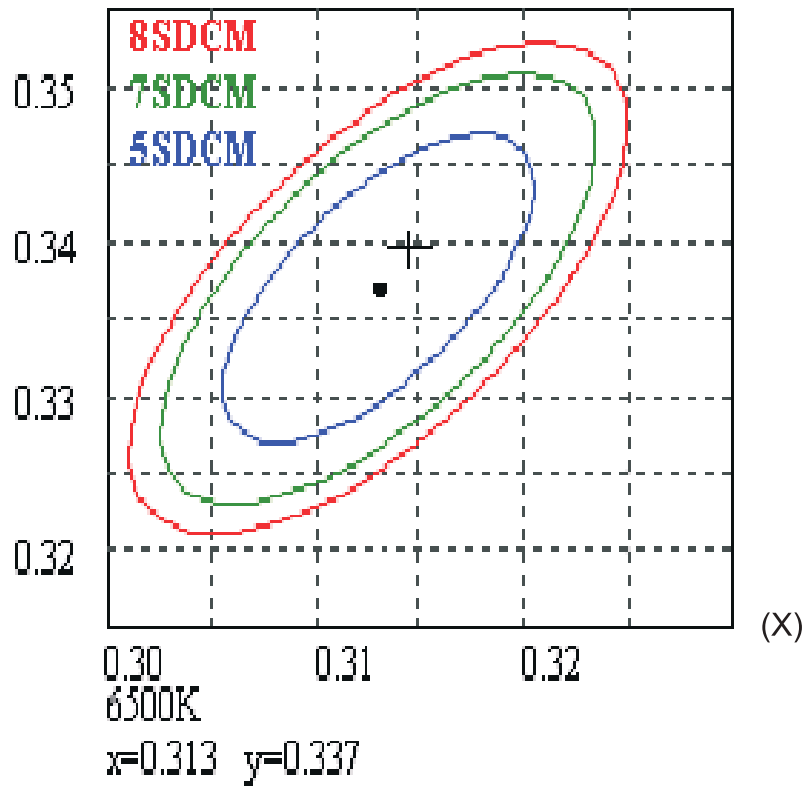

Color Consistency - Initial

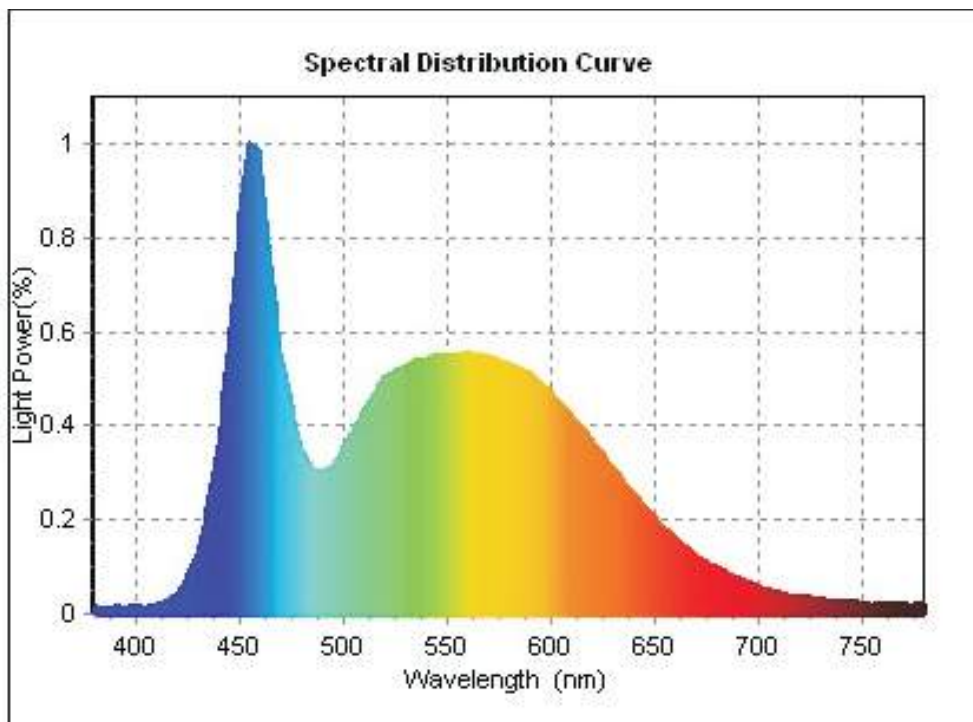

Spectral Power Distribution



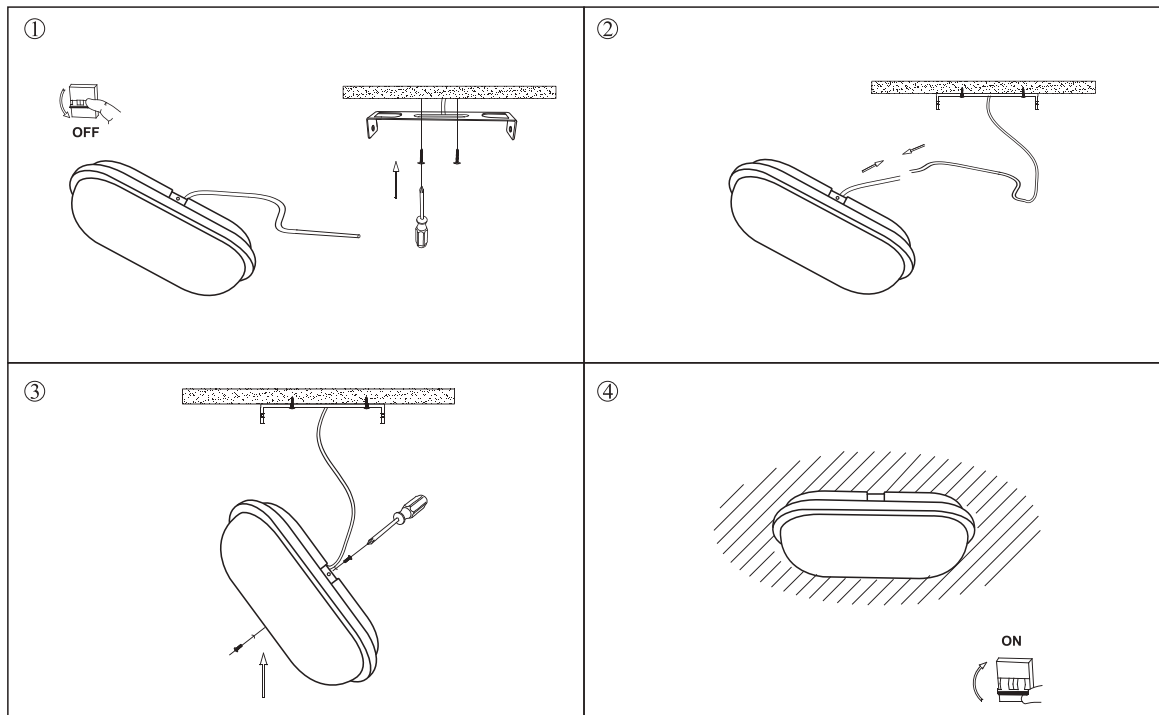



## 9 . Installation



Pay Attention:

1. It's better be installed in the open place in order to heat dissipation.
2. The dust on the lamp should be cleaned termly to ensure good dissipation.

## 10 .Notes

-  Do not attempt to install or use a fixture until you read and understand the installation instructions and safety label.
-  Fixtures have line voltage risk of shock and no user serviceable parts.Do not attempt to open them.
-  Do not hot swap fixtures.Ensure that power to the series is off before connecting or disconnecting individual fixtures.
-  Do not use a fixture if the lens,housing,or power cables are damaged.
-  Do not use a fixture for any voltage for which it is not rated. Do not exceed the specified voltage and current input for any fixture.
-  Do not use the eye to see the light source directly.