

# LED DOWN LIGHT (FOR PROJECT) DESCRIPTION

NS-XH-7W



Specification

## 1 . Lighting Design Related Detail Sketches



## 2 . Dimension

Size:100x55mm

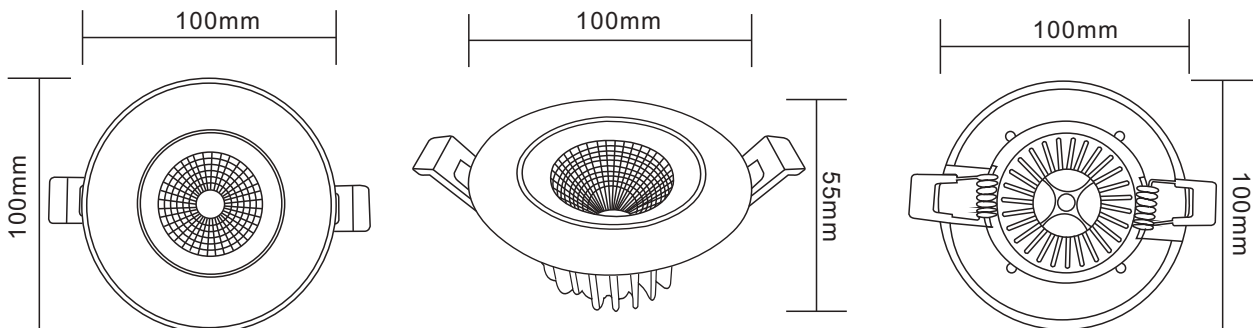

## 3 . Description

- High efficiency, low energy consumption.
- Good quality beam.
- Long life span 30000 hours.
- Ecological. The waste can be recycled.No pollution and mercury.



## 4 . Technical parameter

### Specification

#### PRODUCT SPECIFICATION

<b>Dimension:</b>	100xH55mm
<b>LED package:</b>	COB
<b>LED quantity:</b>	1PCS
<b>Beam angle:</b>	60°
<b>Color temperature:</b>	3000K/6500K
<b>CRI:</b>	≥80
<b>Lifetime:</b>	30,000 hours
<b>Operating temp:</b>	Ta=-25 to 60°C (Tc max=70°C)
<b>IP Rating:</b>	IP20
<b>Warranty:</b>	5 Years

#### PERFORMANCE DATA

<b>Power consumption:</b>	7W
<b>Frequency range:</b>	50Hz/60Hz
<b>Supply voltage:</b>	AC220-240V
<b>Output current:</b>	280mA
<b>Power factor:</b>	>0.5
<b>Luminous flux:</b>	580

## 5 . Light Distribution Curve

### Distribution Curve of Meridian

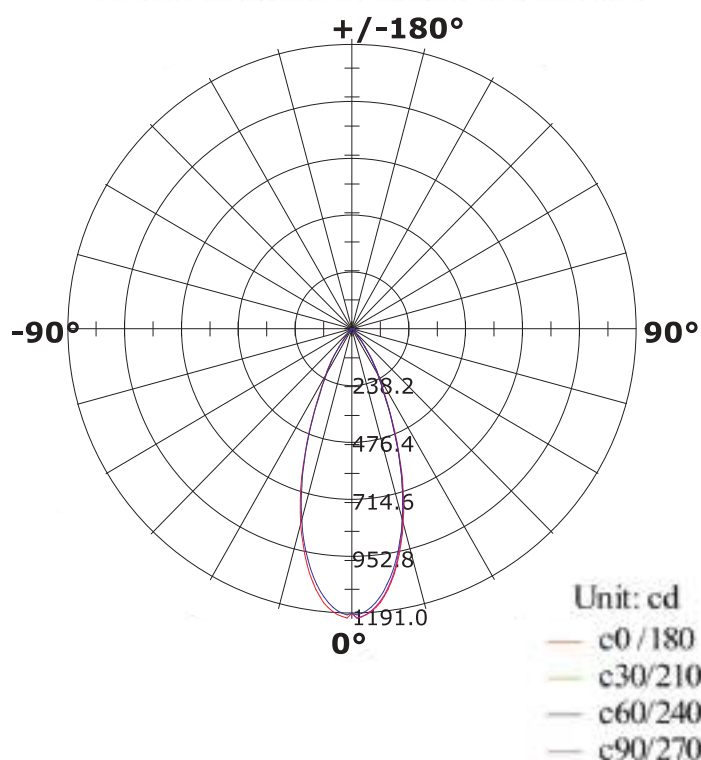



## 6. Illumination Cone Curve

### Specification

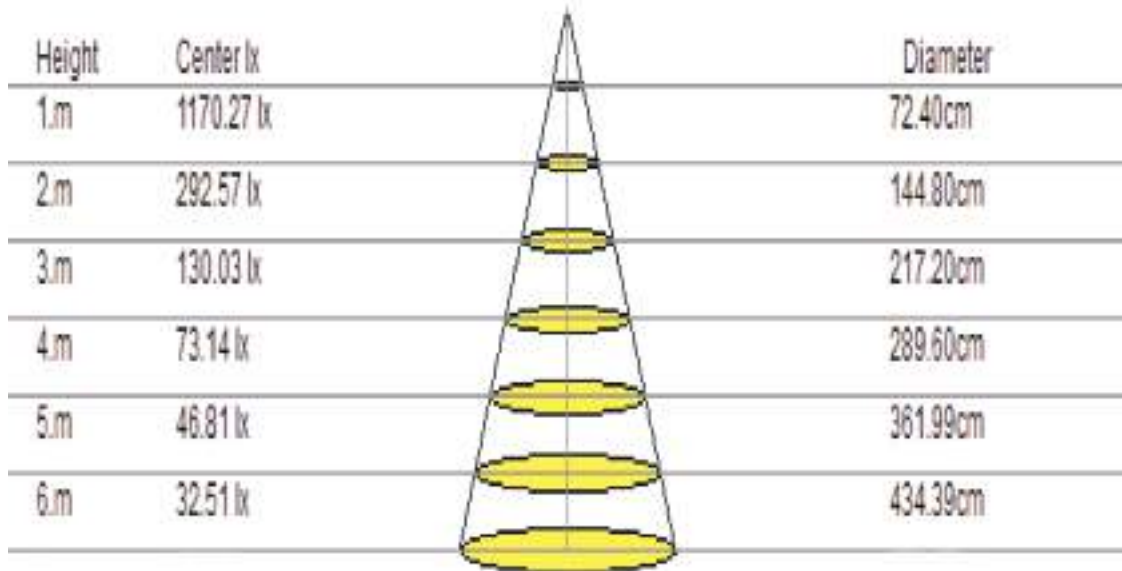

## 7. Horizontal Isophotes Curve

### Horizontal Absolute Isophotes Curve

Height of calculation: 6 m, Illumination in the vertical of Lamp: 32.51 lx

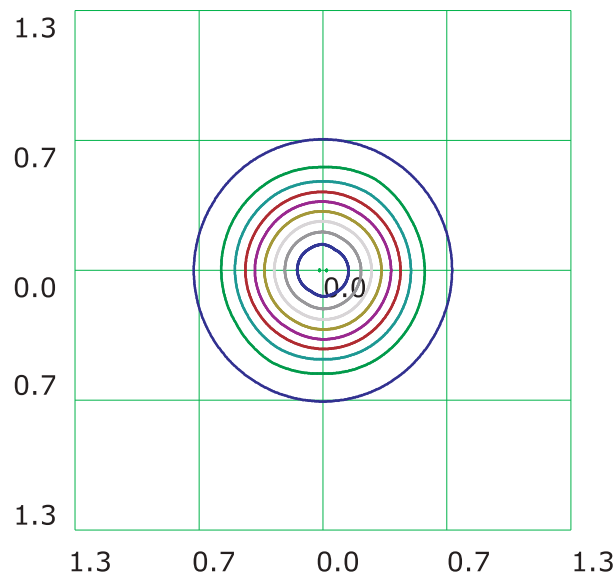

Height: 1M

(10%): 119.1lx    (20%): 238.2lx    (30%): 357.3lx    (40%): 476.4lx  
 (50%): 595.5lx    (60%): 714.6lx    (70%): 833.7lx    (80%): 952.8lx  
 (90%): 1071.9lx    (100%): 1189.8lx



## Specification

# 8 Color Information

(Y)

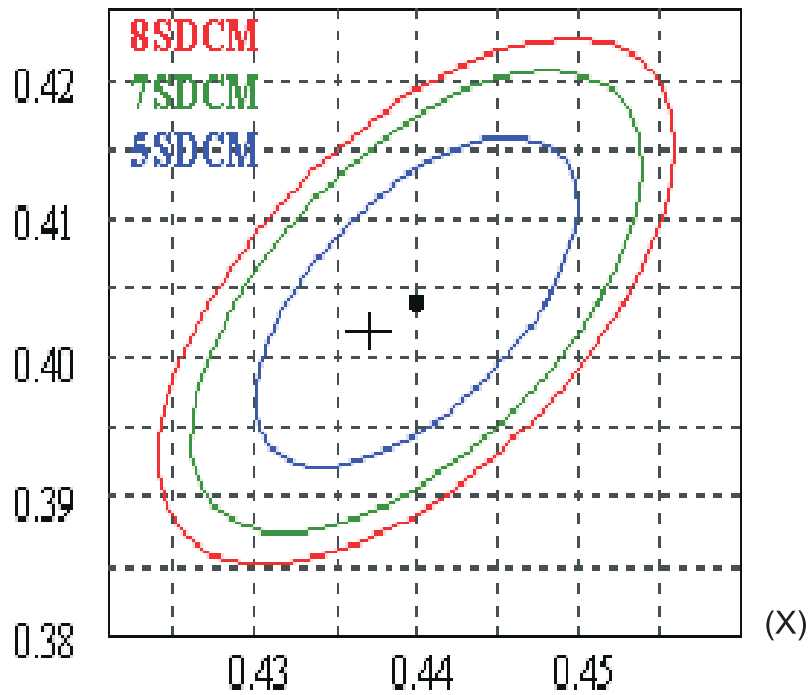

3000K

$x=0.440$   $y=0.403$

Color Consistency - Initial

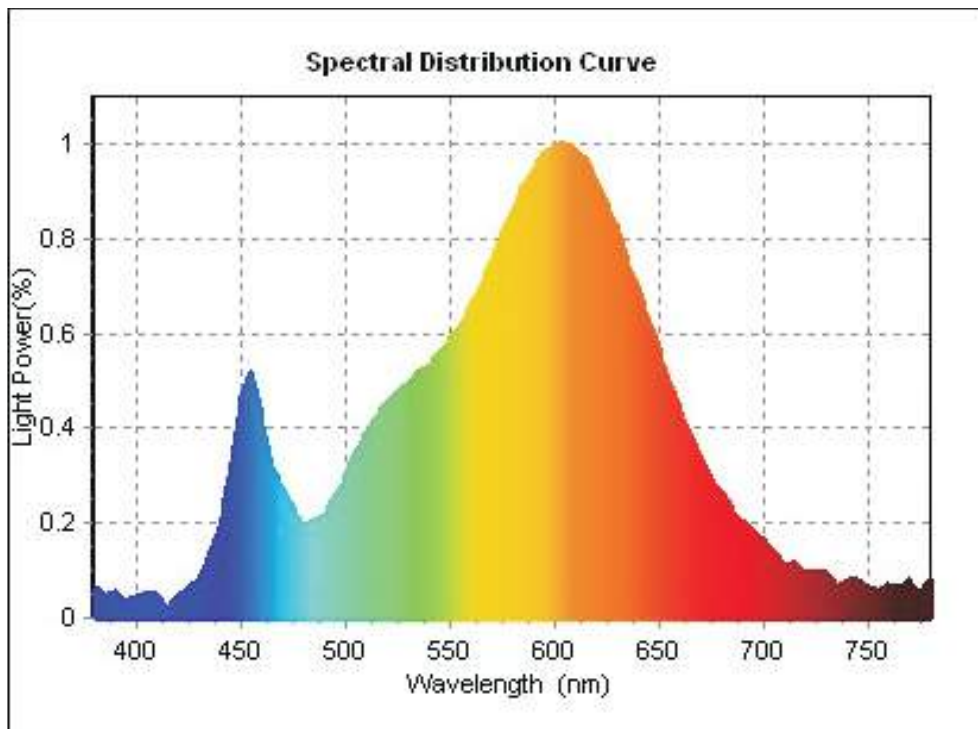

Spectral Power Distribution



## Specification

## Color Information

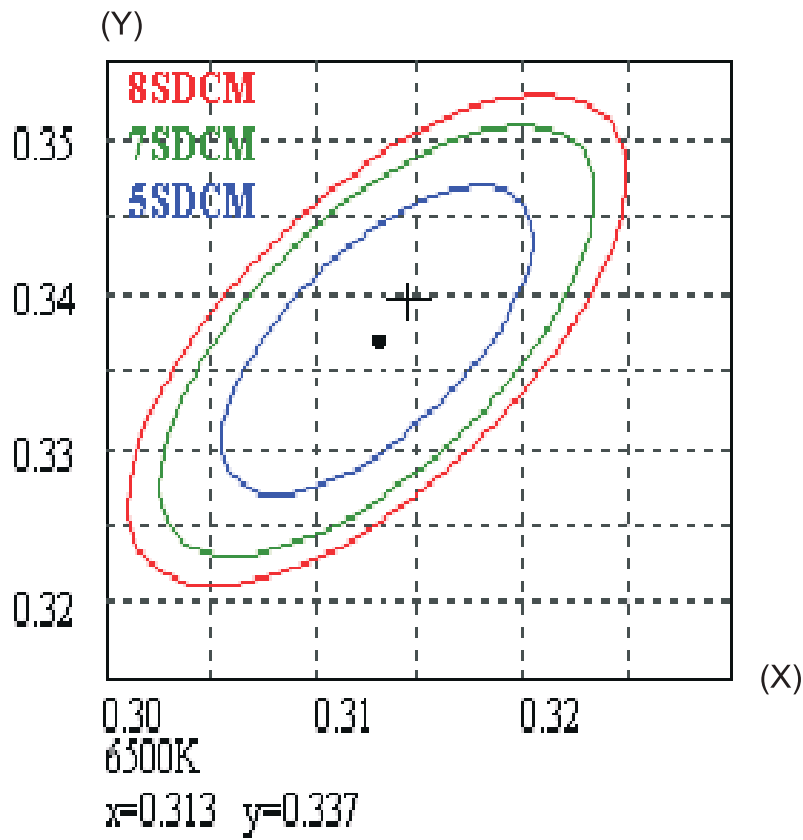

## Color Consistency - Initial

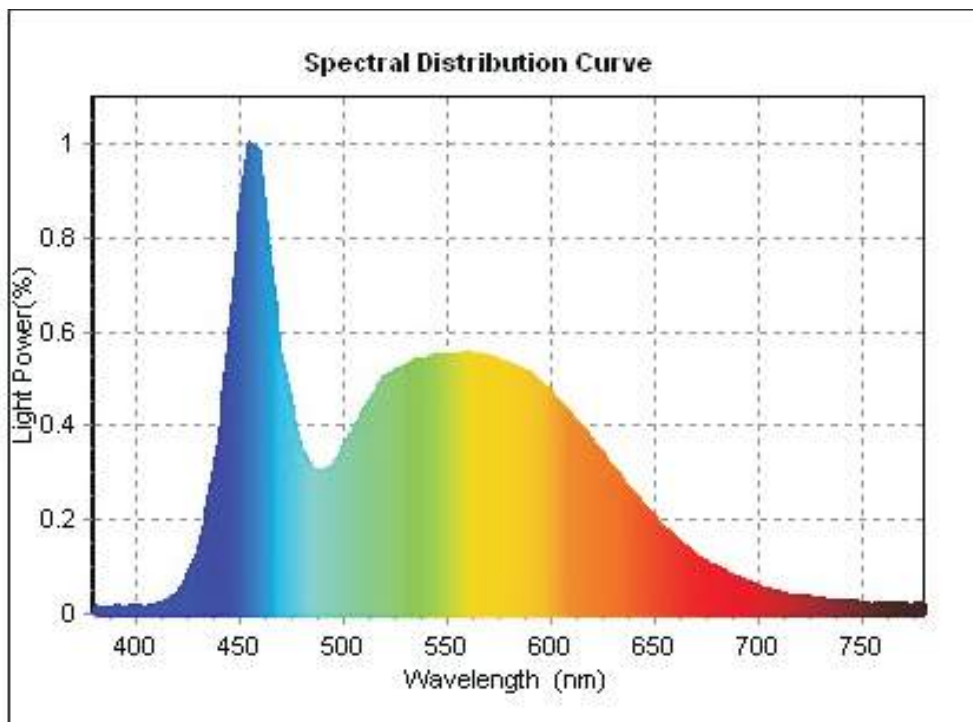

## Spectral Power Distribution



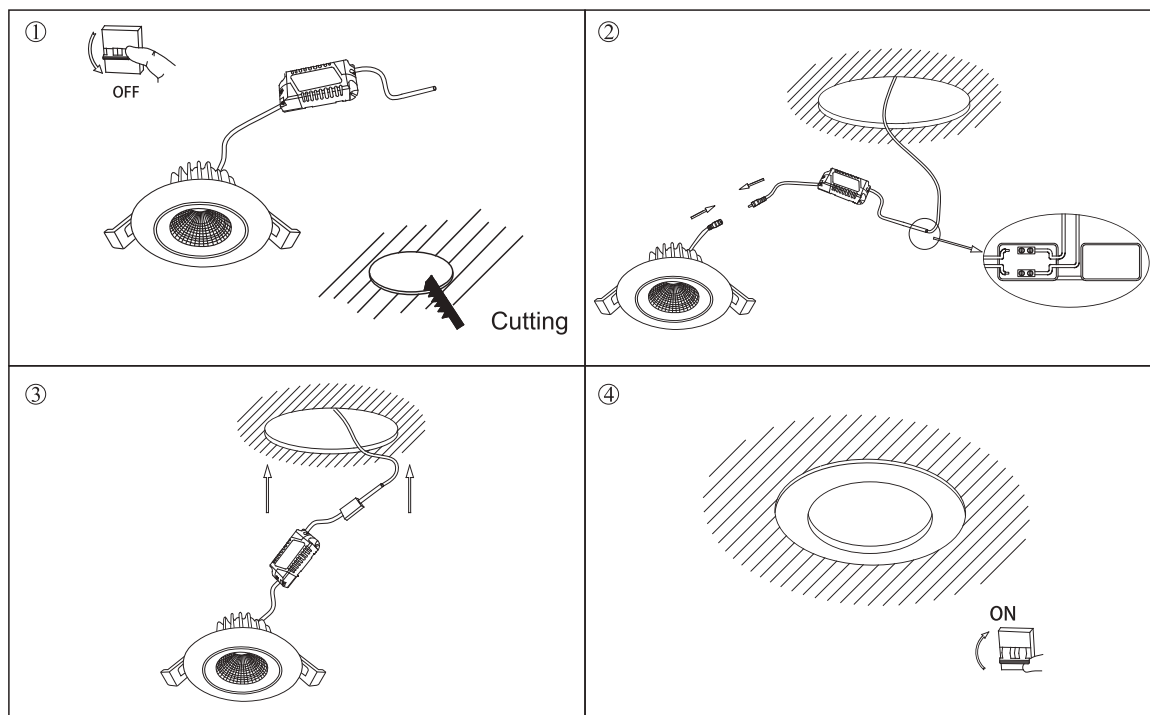



## 9 . Installation



### Pay Attention:

1. It's better be installed in the open place in order to heat dissipation.
2. The dust on the lamp should be cleaned termly to ensure good dissipation.
3. Please Don't install it outdoor!

## 10 .Notes

-  Do not attempt to install or use a fixture until you read and understand the installation instructions and safety label.
-  Fixtures have line voltage risk of shock and no user serviceable parts. Do not attempt to open them.
-  Do not hot swap fixtures. Ensure that power to the series is off before connecting or disconnecting individual fixtures.
-  Do not use a fixture if the lens, housing, or power cables are damaged.
-  Do not use a fixture for any voltage for which it is not rated. Do not exceed the specified voltage and current input for any fixture.
-  Do not use the eye to see the light source directly.