

# LED PANEL LIGHT (FOR PROJECT) DESCRIPTION

## NS-SF-20W-S/NS-SF-20W-R



### Specification

#### 1. Lighting Design Related Detail Sketches



#### 2. Dimension

Size:225x225x35mm

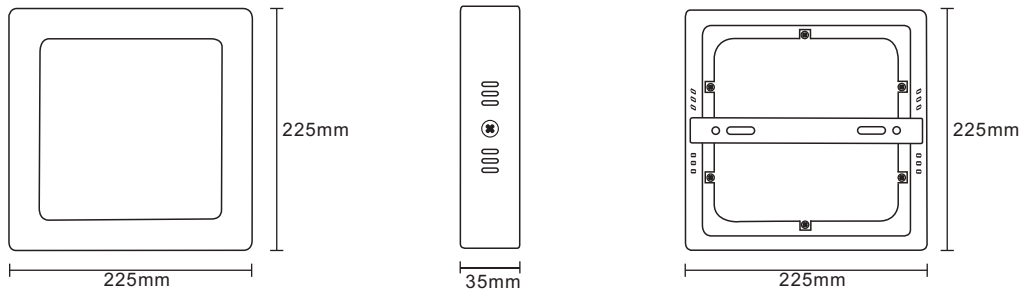

Size:225x35mm

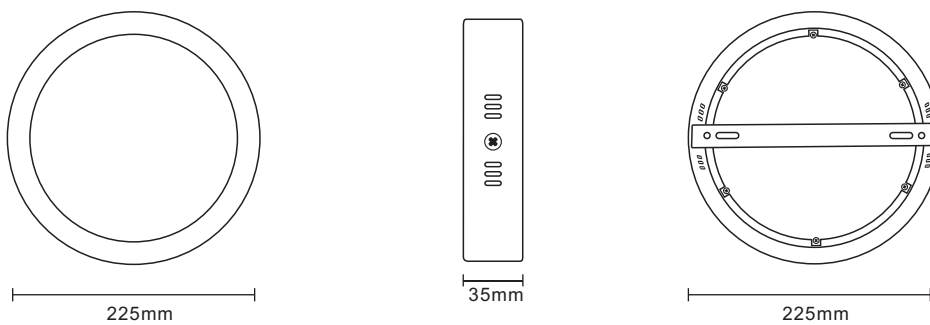

#### 3. Description

- High efficiency, low energy consumption.
- Good quality beam.
- Long life span 30000 hours.
- Ecological. The waste can be recycled.No pollution and mercury.



## 4 . Technical parameter

## Specification

### PRODUCT SPECIFICATION

Dimension:	225x225xH35mm
LED package:	2835
LED quantity:	100PCS
Beam angle:	120°
Color temperature:	6500K-7000K
CRI:	≥80
Lifetime:	30,000 hours
Operating temp:	Ta=-25 to 60°C (Tc max=70°C)
IP Rating:	IP20
Warranty:	5 Years

### PERFORMANCE DATA

Power consumption:	20W
Frequency range:	50Hz/60Hz
Supply voltage:	AC220-240V
Output current:	300mA
Power factor:	>0.9
Luminous flux:	1700

## 5 . Light Distribution Curve

### Distribution Curve of Meridian

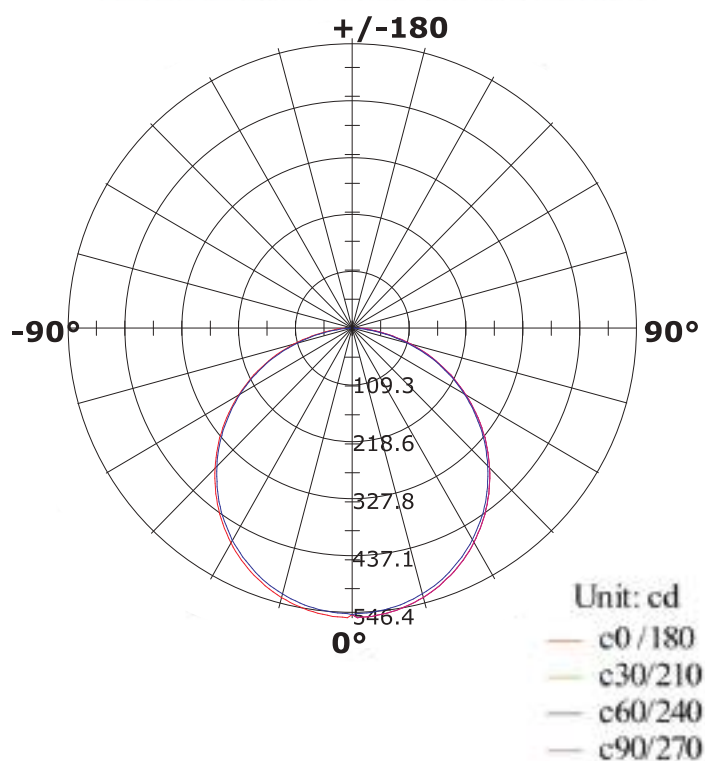



## 6. Illumination Cone Curve

### Specification

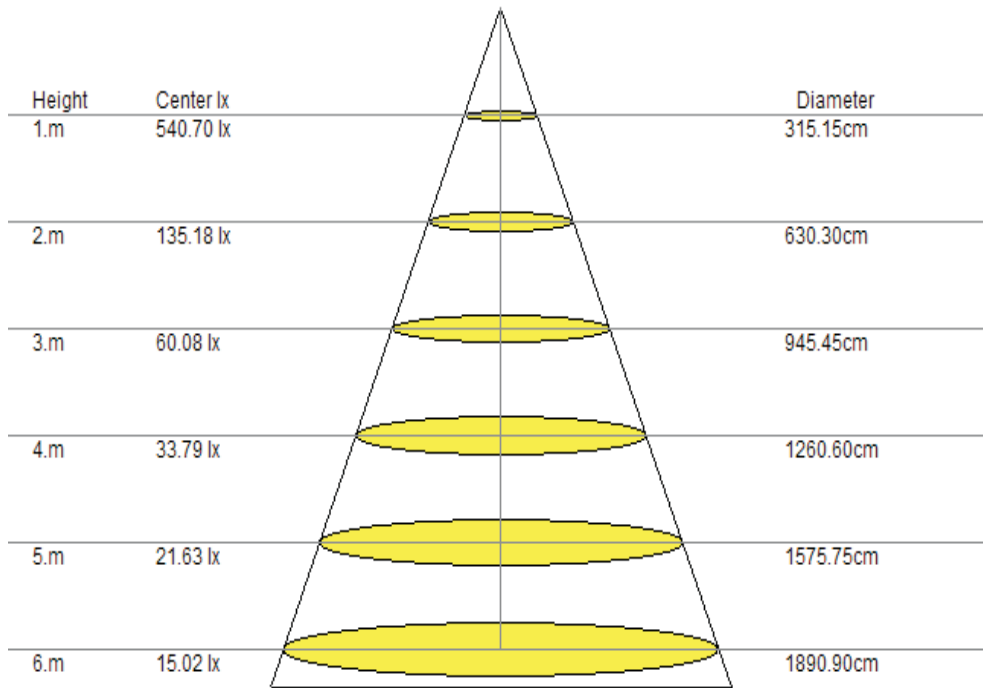

## 7. Horizontal Isophotes Curve

### Horizontal Absolute Isophotes Curve

Height of calculation: 6 m, Illumination in the vertical of Lamp: 15.02 lx

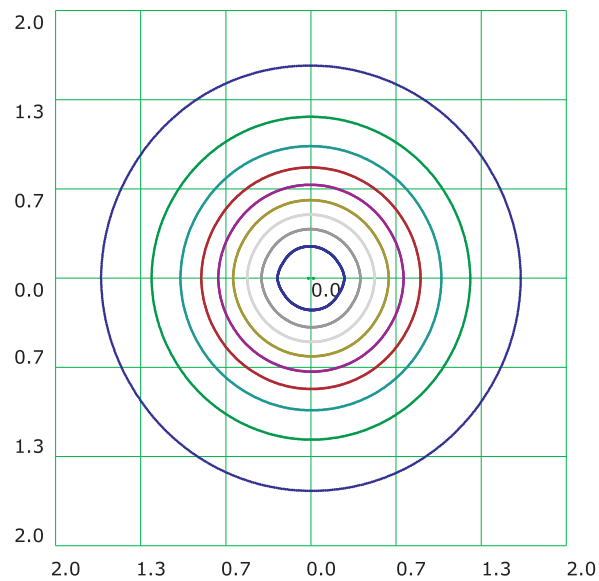

Height: 1 m

- (10%): 54.6lx      (20%): 109.3lx      (30%): 163.9lx      (40%): 218.6lx
- (50%): 273.2lx      (60%): 327.9lx      (70%): 382.5lx      (80%): 437.1lx
- (90%): 491.8lx      (100%): 545.9lx



Specification

## 8 Color Information

(Y)

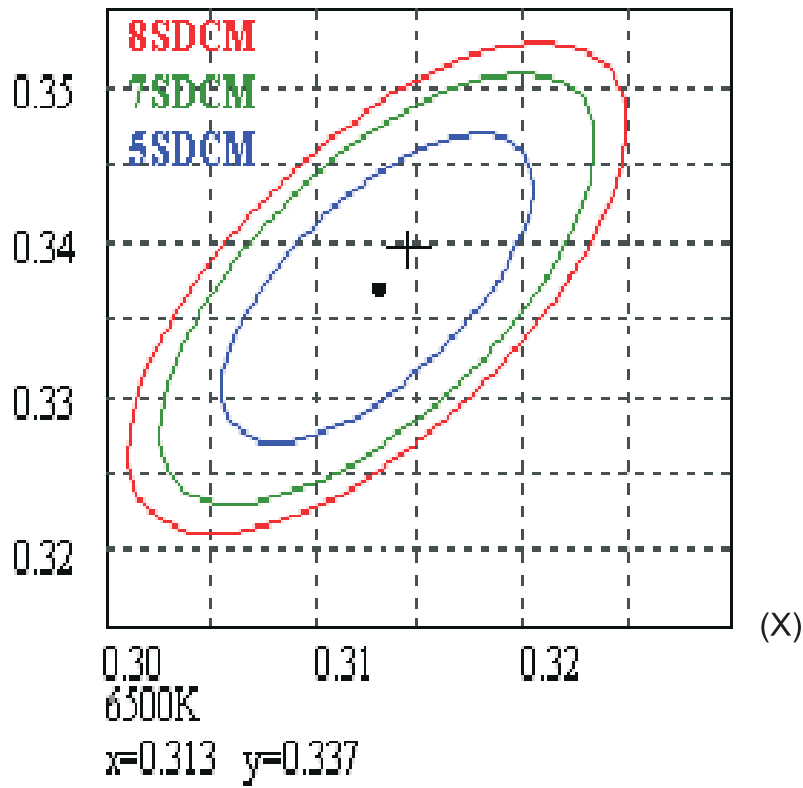

Color Consistency - Initial

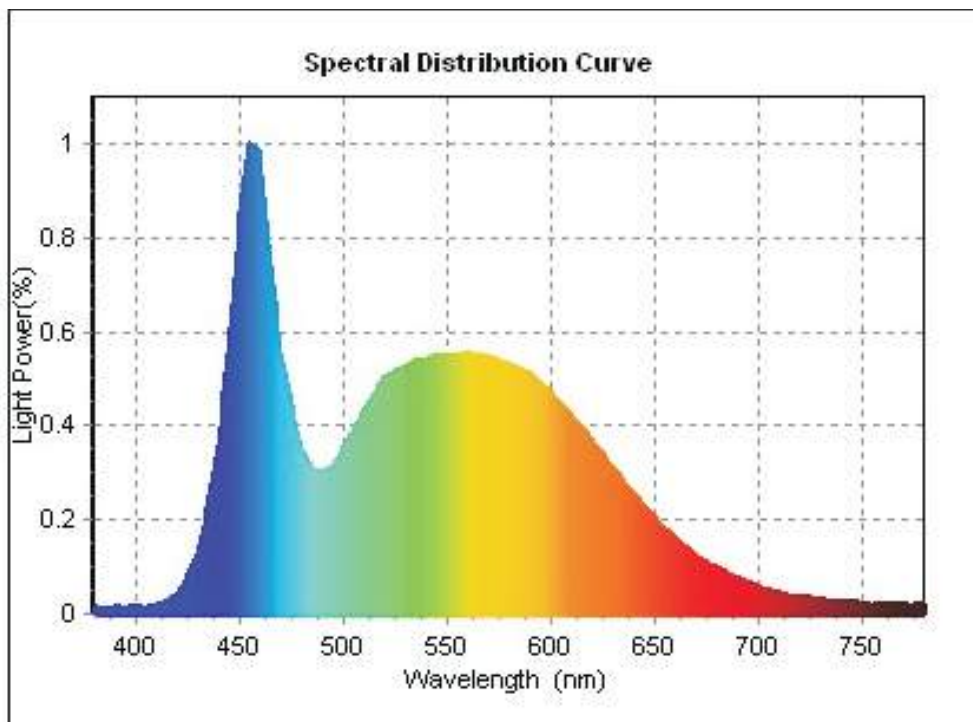

Spectral Power Distribution

## 9 . Installation





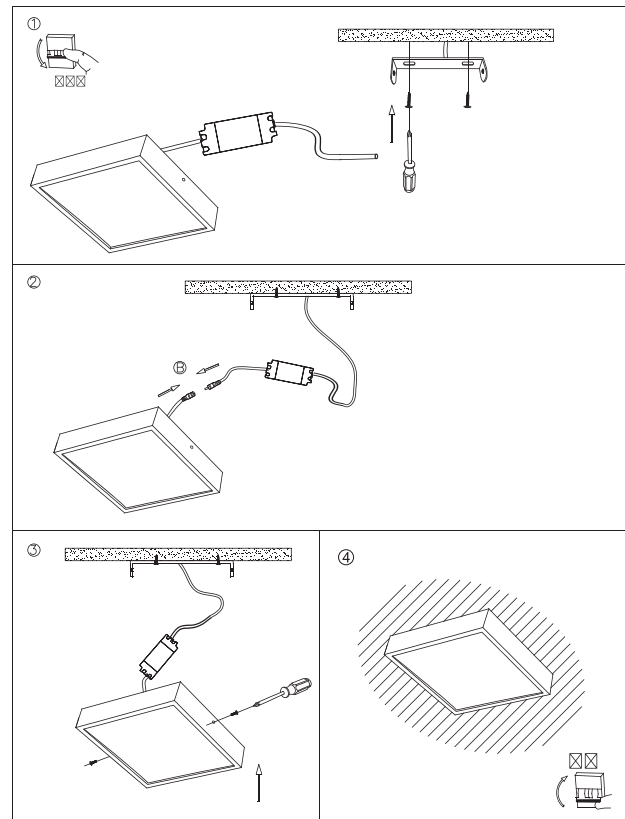
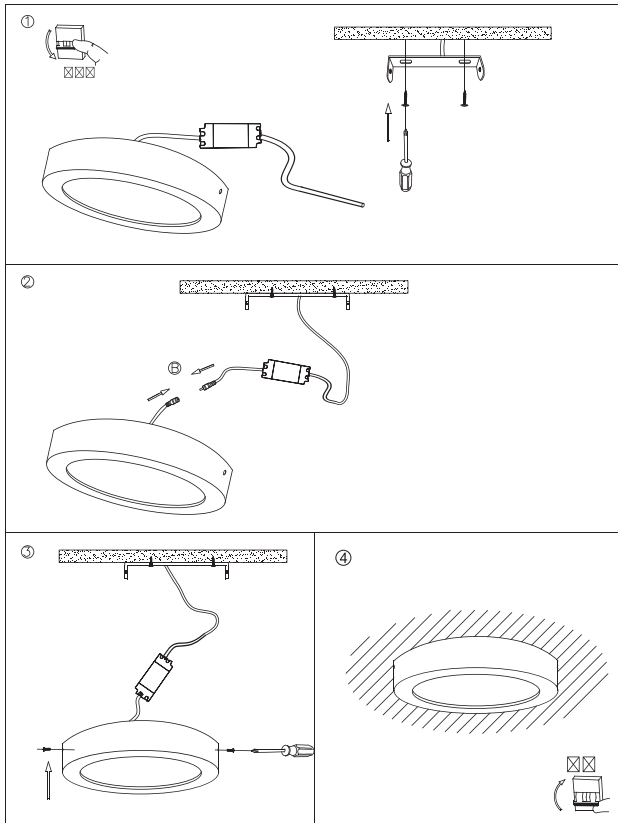



### Installation Instructions



#### Pay Attention:

1. It's better be installed in the open place in order to heat dissipation.
2. The dust on the lamp should be cleaned termly to ensure good dissipation.
3. Please Don't install it outdoor!

## 10 .Notes

-  Do not attempt to install or use a fixture until you read and understand the installation instructions and safety label.
-  Fixtures have line voltage risk of shock and no user serviceable parts. Do not attempt to open them.
-  Do not hot swap fixtures. Ensure that power to the series is off before connecting or disconnecting individual fixtures.
-  Do not use a fixture if the lens, housing, or power cables are damaged.
-  Do not use a fixture for any voltage for which it is not rated. Do not exceed the specified voltage and current input for any fixture.
-  Do not use the eye to see the light source directly.