

LED PANEL LIGHT (FOR PROJECT) DESCRIPTION

NS-S-12W/NS-R-12W



Specification

1. Lighting Design Related Detail Sketches



2. Dimension

Size: 170x170x23mm

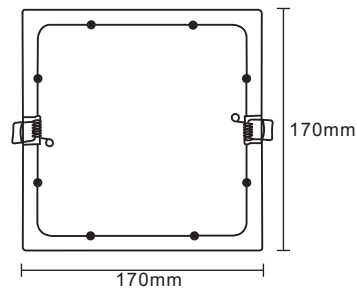
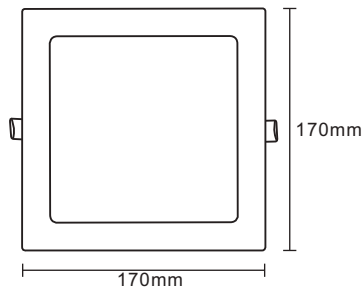

Size: 170x23mm

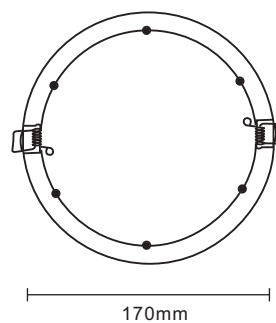
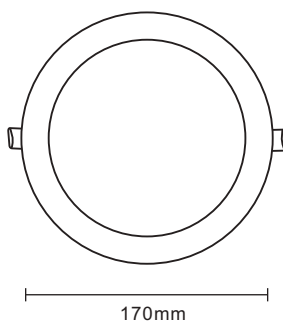

3. Description

- High efficiency, low energy consumption.
- Good quality beam.
- Long life span 30000 hours.
- Ecological. The waste can be recycled.No pollution and mercury.



4 . Technical parameter

Specification

PRODUCT SPECIFICATION

Dimension:	170x170xH23mm
LED package:	2835
LED quantity:	60PCS
Beam angle:	120°
Color temperature:	2800K-3200K
CRI:	≥80
Lifetime:	30,000 hours
Operating temp:	Ta=-25 to 60°C (Tc max=70°C)
IP Rating:	IP20
Warranty:	5 Years

PERFORMANCE DATA

Power consumption:	12W
Frequency range:	50Hz/60Hz
Supply voltage:	AC220-240V
Output current:	300mA
Power factor:	>0.9
Luminous flux:	900

5 . Light Distribution Curve

Distribution Curve of Meridian

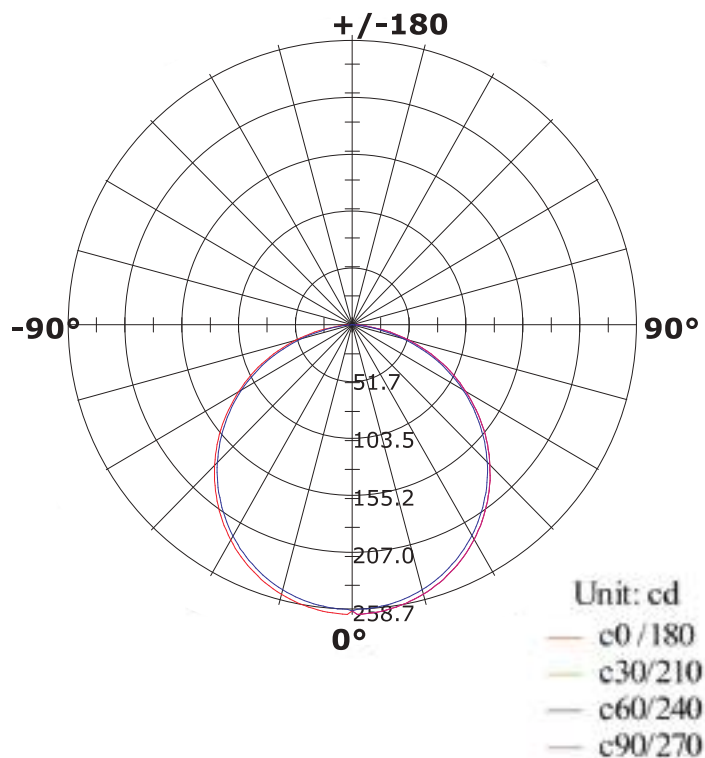



6. Illumination Cone Curve

Specification

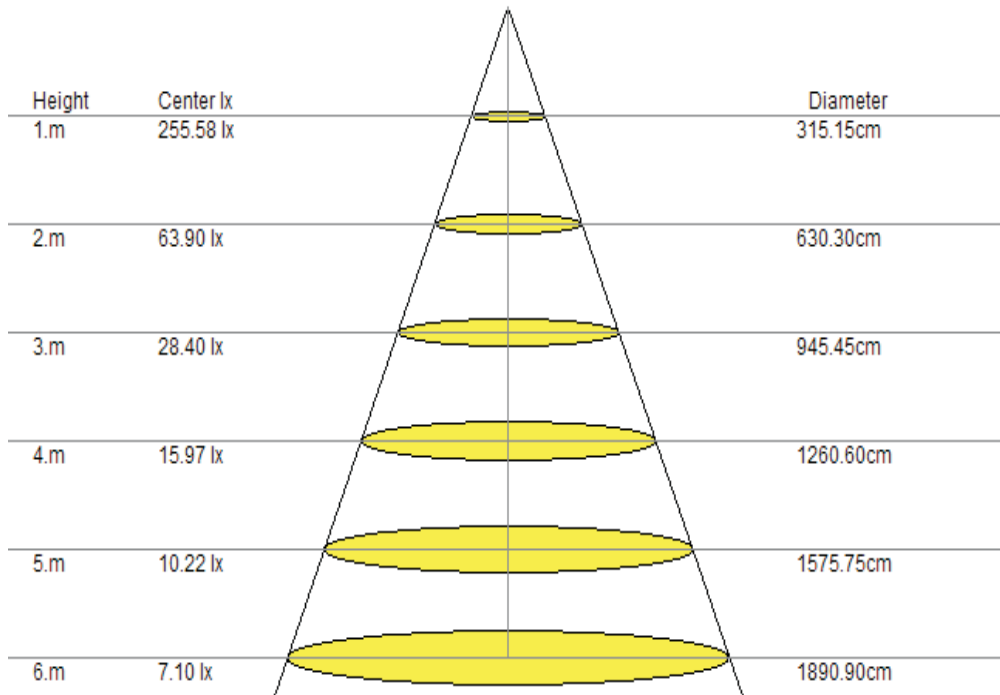

7. Horizontal Isophotes Curve

Horizontal Absolute Isophotes Curve

Height of calculation: 6 m, Illumination in the vertical of Lamp: 7.10 lx

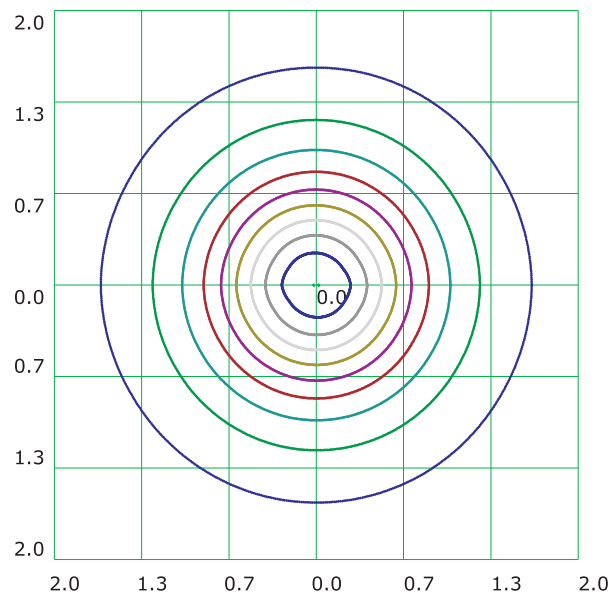

Height: 1 m

(10%): 25.9lx	(20%): 51.8lx	(30%): 77.6lx	(40%): 103.5lx
(50%): 129.4lx	(60%): 155.2lx	(70%): 181.1lx	(80%): 207.1lx
(90%): 232.9lx	(100%): 258.5lx		



Specification

8 Color Information

(Y)

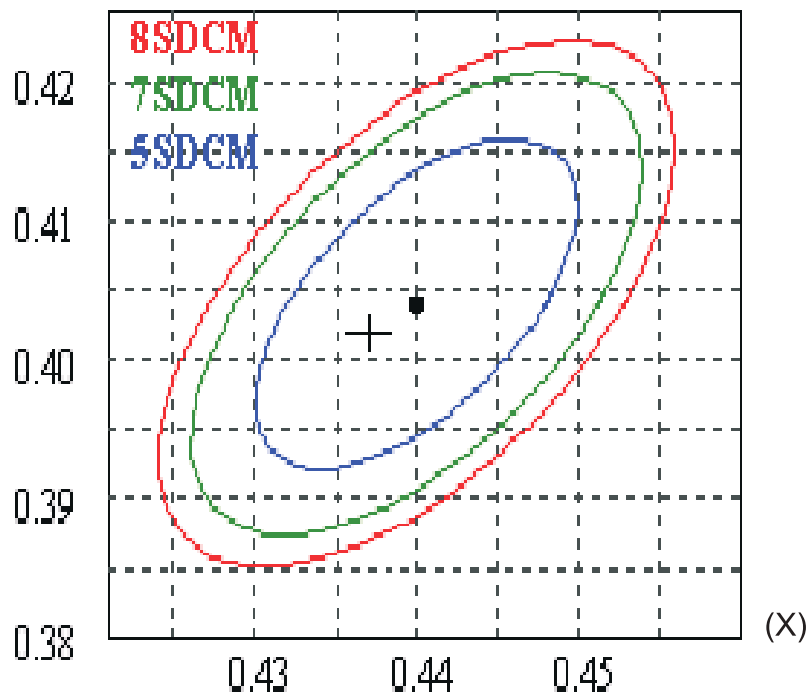

3000K

$x=0.440$ $y=0.403$

Color Consistency - Initial

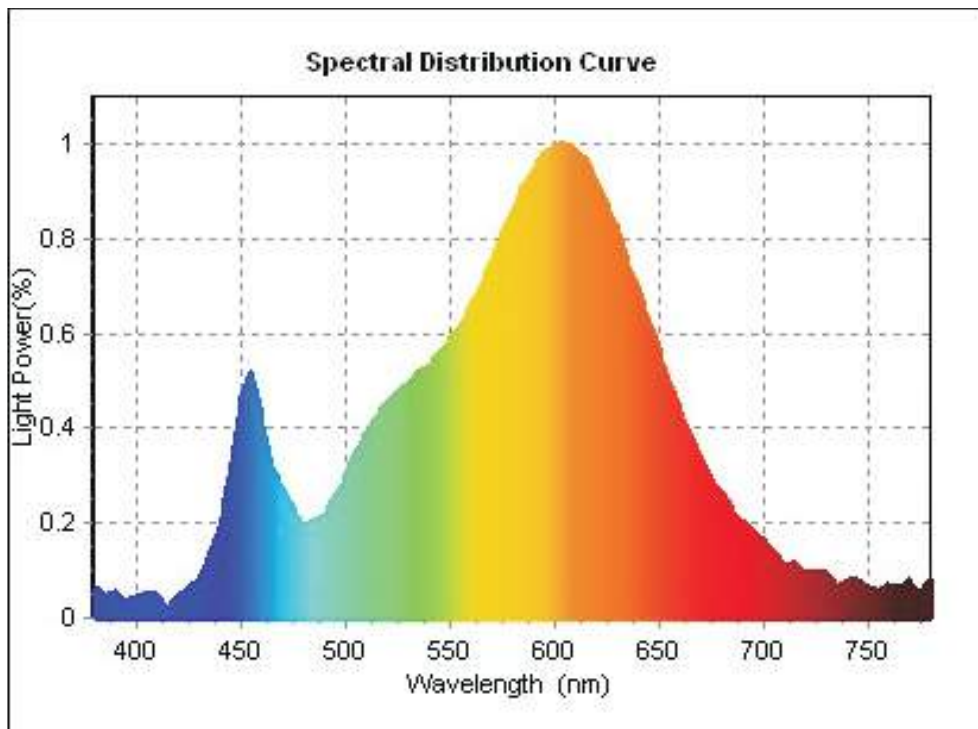

Spectral Power Distribution



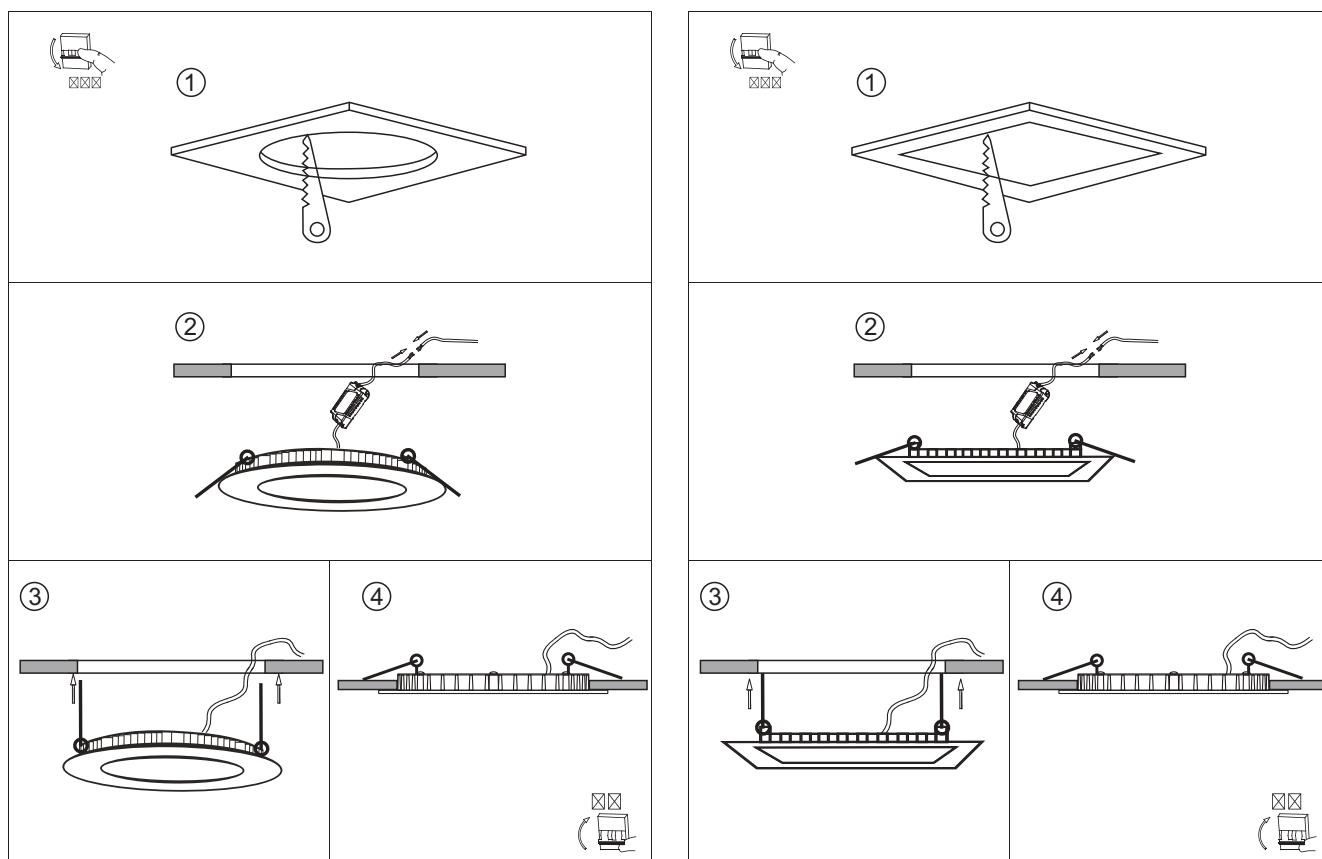



9 . Installation



Pay Attention:

1. It's better be installed in the open place in order to heat dissipation.
2. The dust on the lamp should be cleaned termly to ensure good dissipation.
3. Please Don't install it outdoor!

10 .Notes

-  Do not attempt to install or use a fixture until you read and understand the installation instructions and safety label.
-  Fixtures have line voltage risk of shock and no user serviceable parts. Do not attempt to open them.
-  Do not hot swap fixtures. Ensure that power to the series is off before connecting or disconnecting individual fixtures.
-  Do not use a fixture if the lens, housing, or power cables are damaged.
-  Do not use a fixture for any voltage for which it is not rated. Do not exceed the specified voltage and current input for any fixture.
-  Do not use the eye to see the light source directly.