

# LED FLOODLIGHT(FOR PROJECT)DESCRIPTION

NS-FLA-100



Specification

## 1 . Lighting Design Related Detail Sketches



## 2 . Dimension

Size:298x268x62mm

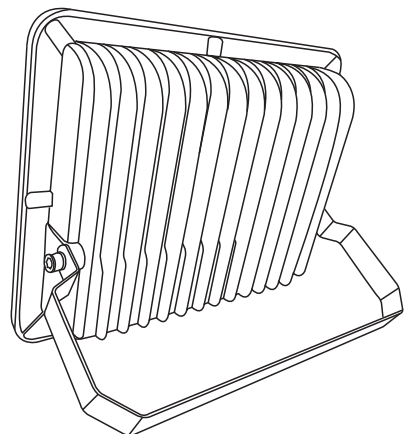
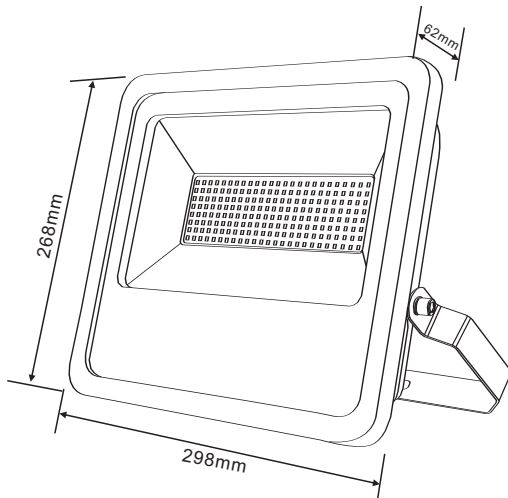

## 3 . Description

- High efficiency, low energy consumption.
- Good quality beam.
- Long life span 30000 hours.
- Ecological. The waste can be recycled.No pollution and mercury.



## 4 . Technical parameter

### Specification

#### PRODUCT SPECIFICATION

Dimension:	298x268xH62mm
LED package:	2835
LED quantity:	200PCS
Beam angle:	120°
Color temperature:	3000K/6500K
CRI:	≥80
Lifetime:	30,000 hours
Operating temp:	Ta=-25 to 60°C (Tc max=70°C)
IP Rating:	IP66
Warranty:	5 Years

#### PERFORMANCE DATA

Power consumption:	100W
Frequency range:	50Hz/60Hz
Supply voltage:	AC220-240V
Output current:	1500mA*2
Power factor:	>0.9
Luminous flux:	9000

## 5 . Light Distribution Curve

### Distribution Curve of Meridian

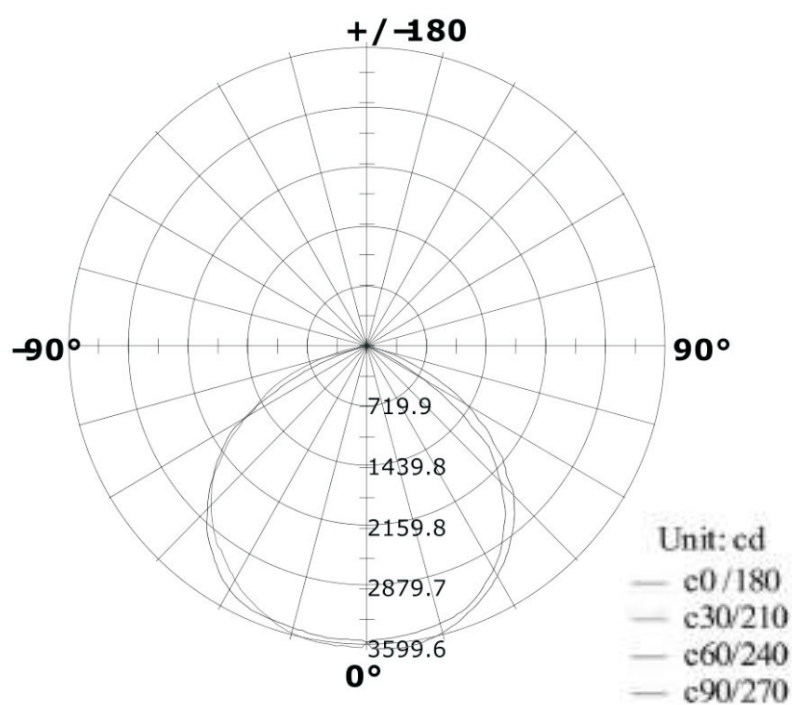



## 6. Illumination Cone Curve

### Specification

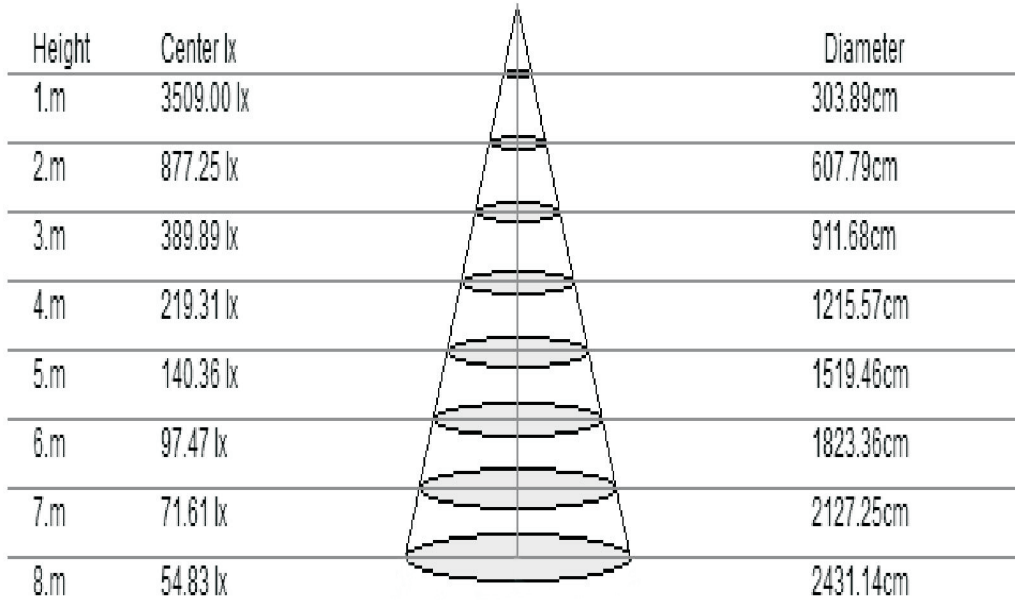

## 7. Horizontal Isophotes Curve

### Horizontal Absolute Isophotes Curve

Height of calculation: 8 m, Illumination in the vertical of Lamp: 54.83 lx

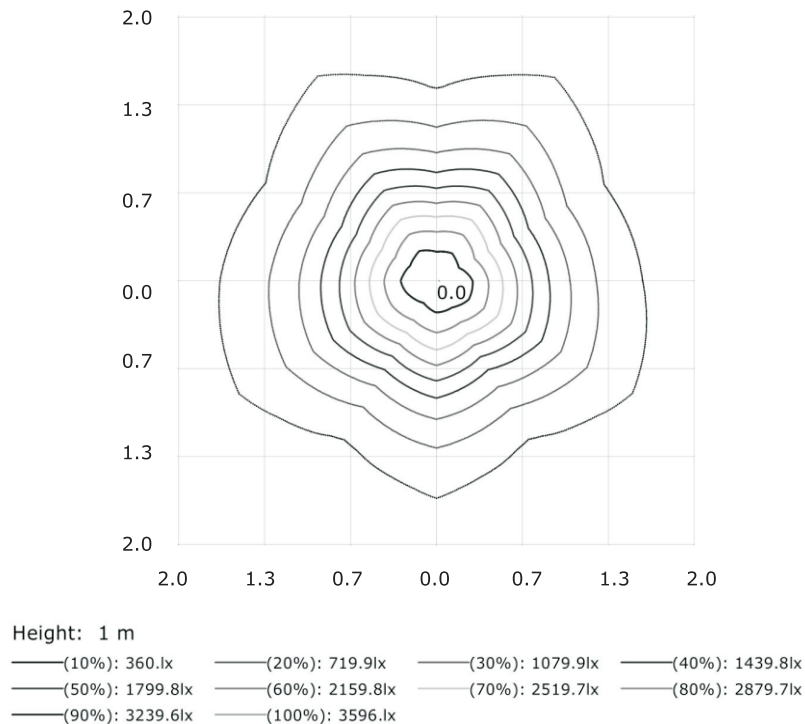



Specification

## 8 Color Information

(Y)

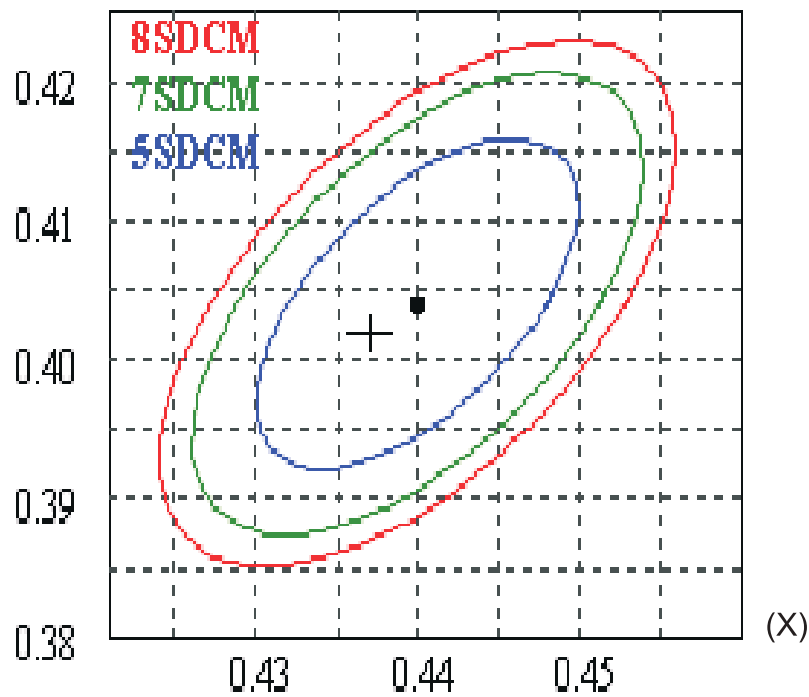

3000K

$x=0.440$   $y=0.403$

Color Consistency - Initial

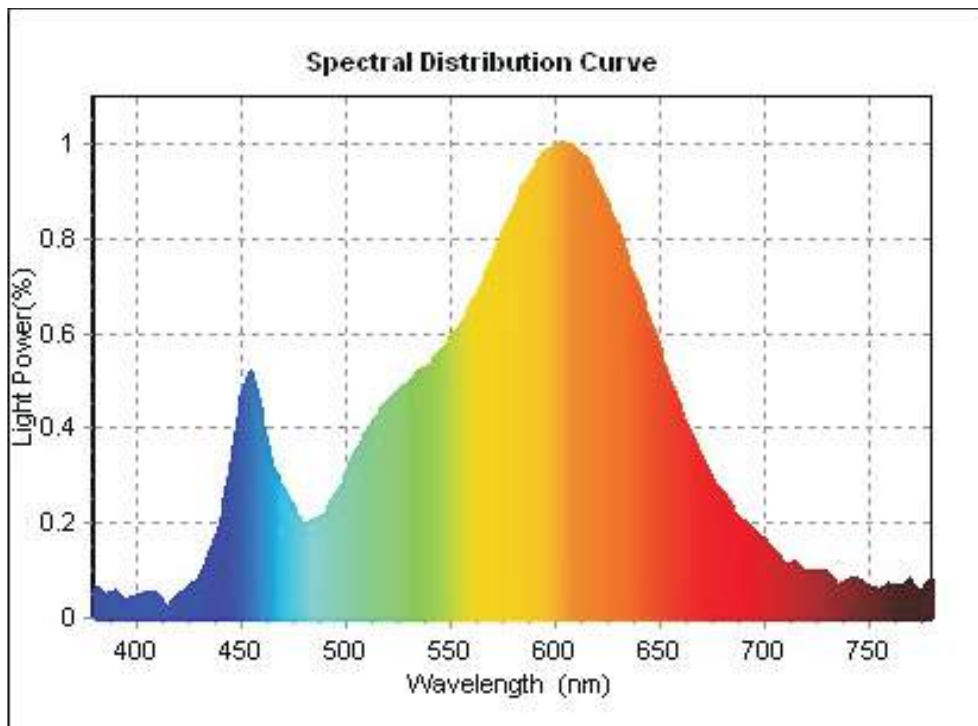

Spectral Power Distribution



Specification

## 9 Color Information

(Y)

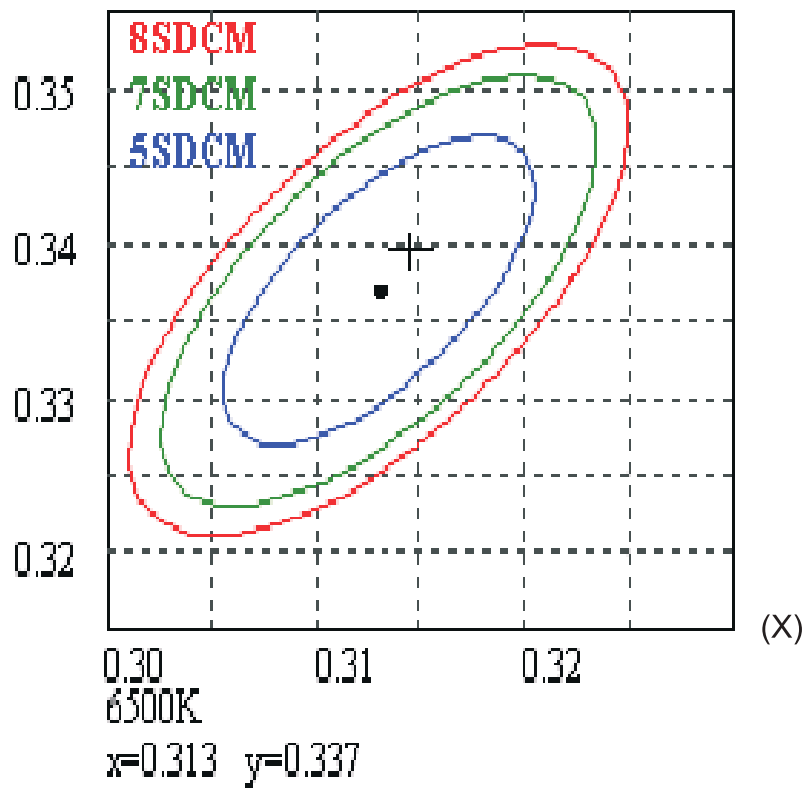

Color Consistency - Initial

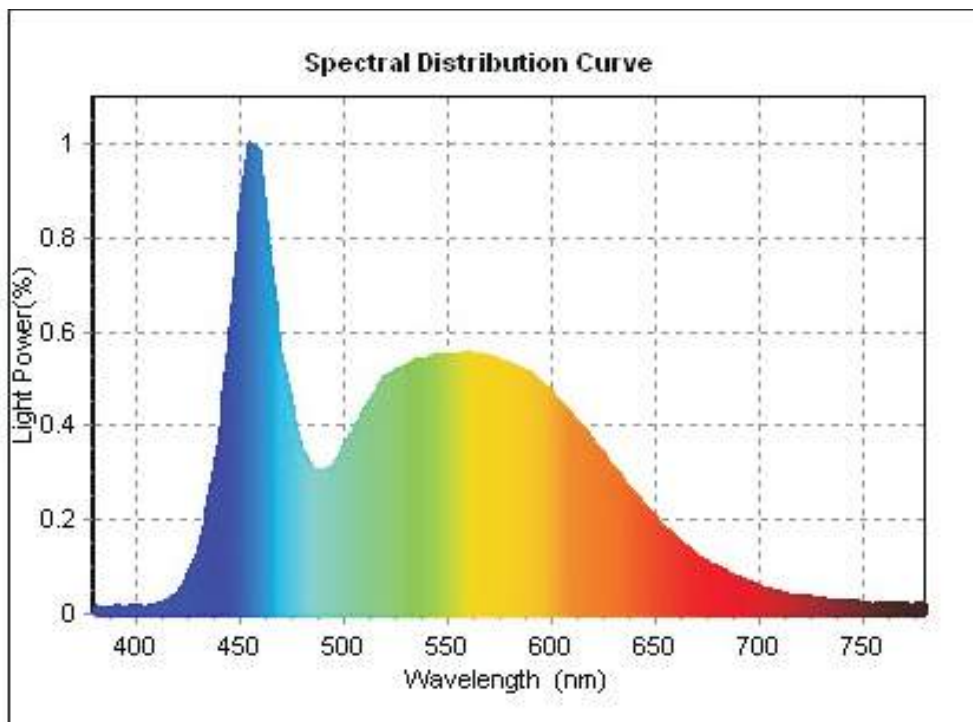

Spectral Power Distribution

# 10 . Installation

## Installation Instructions



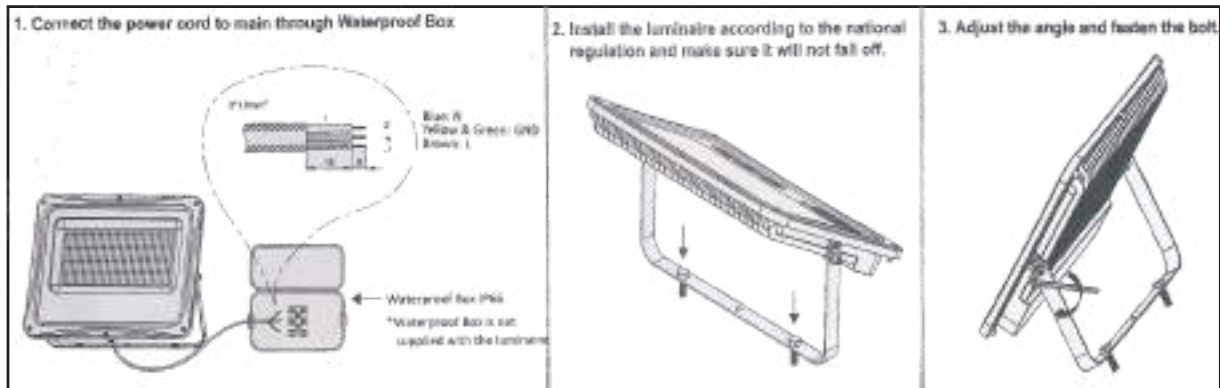



### \* Installation Procedure:



Pay Attention:

1. It's better be installed in the open place in order to heat dissipation.
2. The dust on the lamp should be cleaned termly to ensure good dissipation.

# 11 .Notes

-  Do not attempt to install or use a fixture until you read and understand the installation instructions and safety label.
-  Fixtures have line voltage risk of shock and no user serviceable parts. Do not attempt to open them.
-  Do not hot swap fixtures. Ensure that power to the series is off before connecting or disconnecting individual fixtures.
-  Do not use a fixture if the lens, housing, or power cables are damaged.
-  Do not use a fixture for any voltage for which it is not rated. Do not exceed the specified voltage and current input for any fixture.
-  Do not use the eye to see the light source directly.